

PRICING & SPECIFICATION GUIDE
Montrose Tables

May 1, 2024

TUOHY



Conference: **Montrose**

Wood Top	CMO4
HPL Top	CMO5
Solid Surface Top	CMO6
Fenix Top	CMO7
Back-Painted Glass Top	CMO8
Acid-Etched Top	CMO9
Marble Top	CMO10
Quartz Top	CMO11

Overview

Each Montrose Table may be ordered with 6-inch radius corners or square corners, with one of three base size options, and with power per seat or shared power.

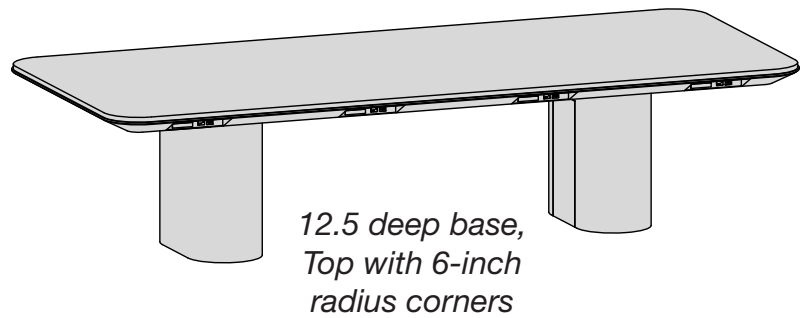
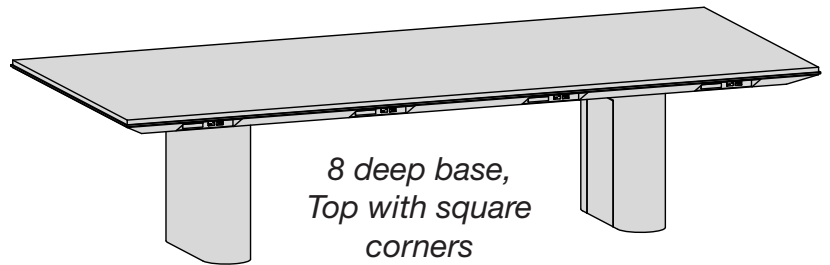
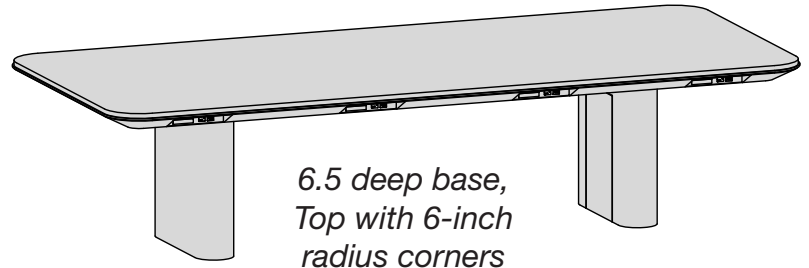

Sections, Segments, and Power

Table sections are based on power option and width. Top segmentation varies by material. Number of Power Units is based on power option, number of seats and top shape. Individual power option includes one power per seat. Shared power option includes one power per two seats.

Table Sections by Power Option and Table Width

	90	96	108	120	132	144	156	168	180	192	204	216	240
Individual Power Option	1	1	1	1	3	3	3	3	3	3	3	2	2
Shared Power Option	1	1	1	1	2	3	3	3	3	3	2	2	2

Top Segments by Material and Table Width

	90	96	108	120	132	144	156	168	180	192	204	216	240
Wood 1 & 2 <small>(all colors; grain long on 1-section tops, short on 2-section tops)</small>	1	1	1	1	2	2	2	2	2	2	2	2	2
HPL Formica® 949 White <small>(PVC as self-edge)</small>	1	1	1	1	2	2	2	2	2	2	2	2	2
Acrylic Solid Surface Avonite® Polaris Matte	1	1	1	1	2	2	2	2	2	2	2	2	2
Fenix <small>(30 Bianco Alaska, 718 Grigio Londra, 720 Nero Ingo)</small>	1	1	1	1	2	2	2	2	2	2	2	2	2
AEGlass Acid-Etched Glass <small>(Wood 1 & 2 subtop where applicable)</small>	1	1	1	2	2	2	2	2	2	3	3	3	4
BPGlass Back-Painted Glass <small>(Wood 1 & 2 subtop where applicable)</small>	1	1	1	2	2	2	2	2	2	3	3	3	4
Marble Carrara Marble	2	2	2	2	2	3	3	3	3	4	4	4	5
Quartz <small>(all Cambria® standard colors; quote required for Cambria Matte™ & Luxury Design Series)</small>	2	2	2	2	2	3	3	3	3	4	4	4	5

Number of Power Units by Power Option and Number of Seats

	90	96	108	120	132	144	156	168	180	192	204	216	240
Individual Power Option													
Rectangle Top	8	8	10	10	12	12	12	14	14	16	16	18	18
Video Top	-	-	-	10	12	12	12	14	14	16	16	18	18
Track Top	10	10	10	12	12	14	14	14	16	16	16	18	18
Shared Power Option													
Rectangle Top	6	6	6	6	8	8	8	8	8	10	10	10	10
Video Top	-	-	-	6	8	8	8	8	8	10	10	10	10
Track Top	5	5	6	6	6	7	7	8	8	8	9	10	10

Individual Power Option Includes One Power Per Seat

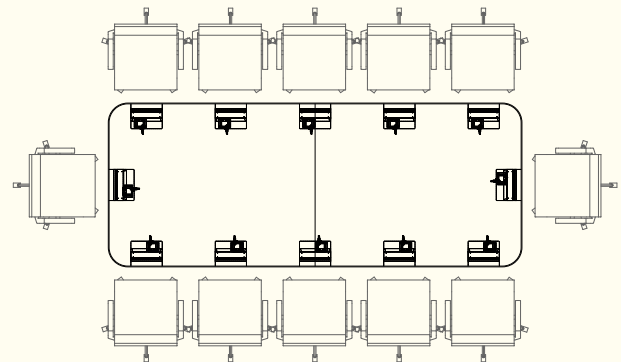

Shared Power Option Includes One Power Per Two Seats

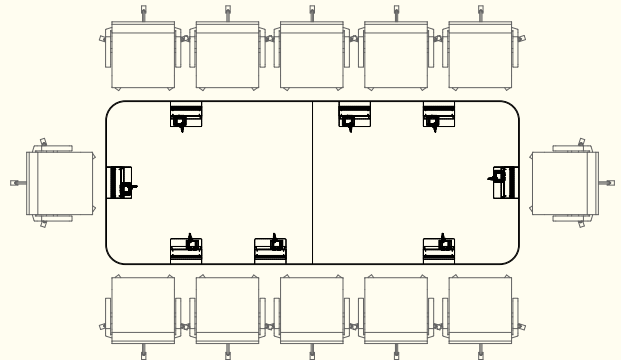

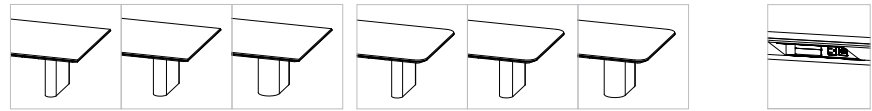

Wood Top, 29.9h ±

Base / Corner Detail Code

Power Options

Shape	sections	pcs	w	d	Seats	Prefix & Top Code	Square Corner Detail			Radius Corner Detail, 6-in Radius			1 per Seat	1 per 2 Seats + Ends		
							6.5-in Bases	8-in Bases	12.5-in Bases	6.5-in Bases	8-in Bases	12.5-in Bases				
	1	1	90	48	8	MTW... ...R6...	...S6 19314	...S8 19700	...S12 20087	...R6 20859	...R8 21276	...R12 21694	P 7786	P2 6130		
			96	48	8	...R7... 19583	19975	20366	21150	21573	21995	7786	6130			
	2	2	108	48	10	...R8... 20121	20523	20926	21731	22165	22600	9442	7786			
			120	52	10	...R9... 26562	27093	27624	28687	29260	29834	9442	7786			
			132	52	12	...R10... 27129	27672	28214	29299	29886	30471	11096	9442			
			144	52	12	...R11... 27697	28251	28805	29913	30511	31109	11096	9442			
			156	56	12	...R12... 29475	30065	30654	31833	32470	33106	11096	9442			
			168	56	14	...R13... 30072	30673	31275	32478	33127	33777	12754	11096			
			180	56	14	...R14... 30668	31281	31895	33121	33783	34447	12754	11096			
			192	60	16	...R15... 31838	32475	33112	34385	35073	35761	14410	12754			
			204	60	16	...R16... 36049	36770	37491	38933	39712	40490	14410	12754			
			216	60	18	...R17... 36675	37409	38142	39609	40402	41193	16064	14410			
			240	60	18	...R18... 37926	38685	39443	40960	41780	42598	16064	14410			
				1	1	120	52/40	10	...V6... 27029	27570	28110	29191	29776	30359	9442	7786
						132	52/40	12	...V7... 27606	28158	28710	29814	30411	31007	11096	9442
				2	2	144	52/40	12	...V8... 28184	28748	29311	30439	31048	31656	11096	9442
						156	56/44	12	...V9... 29994	30594	31194	32394	33042	33690	11096	9442
						168	56/44	14	...V10... 30601	31213	31825	33049	33710	34371	12754	11096
180	56/44	14				...V11... 31208	31832	32456	33705	34379	35052	12754	11096			
192	60/44	16				...V12... 32398	33046	33694	34990	35690	36390	14410	12754			
204	60/44	16				...V13... 36683	37417	38150	39618	40410	41202	14410	12754			
216	60/44	18				...V14... 37320	38066	38813	40306	41111	41918	16064	14410			
240	60/44	18				...V15... 38593	39365	40137	41680	42514	43348	16064	14410			
	1	1				90	48	10	...T6... 19654	20047	20440	—	—	—	9442	7786
						96	48	10	...T7... 19928	20327	20725	—	—	—	9442	7786
	2	2				108	52	10	...T8... 20475	20885	21294	—	—	—	9442	7786
						120	54	12	...T9... 27029	27570	28110	—	—	—	11096	9442
						132	54	12	...T10... 27606	28158	28710	—	—	—	11096	9442
			144	54	14	...T11... 28184	28748	29311	—	—	—	12754	11096			
			156	60	14	...T12... 29994	30594	31194	—	—	—	12754	11096			
			168	60	14	...T13... 30601	31213	31825	—	—	—	12754	11096			
			180	60	16	...T14... 31208	31832	32456	—	—	—	14410	12754			
			192	60	16	...T15... 32398	33046	33694	—	—	—	14410	12754			
			204	60	16	...T16... 36683	37417	38150	—	—	—	14410	12754			
			216	60	18	...T17... 37320	38066	38813	—	—	—	16064	14410			
			240	60	20	...T18... 38593	39365	40137	—	—	—	17720	16064			

No Power Edge Detail

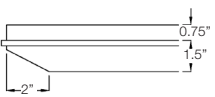

To include (1) Power per Seat, append P to end of product number and add list price.
 To include (1) Power per Every Two Seats + Ends, append P2 to end of product number and add list price.

To Order:

For product numbers, join the Prefix, Top Code and Base/Corner Detail Code; read across and down for price.
 Ex. For 90w 48d Rectangle Wood Top, Square Corners, 8-in Bases, w/ Power, Prod No. is MTWR6S8P; list price is \$27486.

! Notes:

- Priced in Wood1
- Painted Subtop, Black
- Power option includes set number of power units. See Seats/Power Units for qty per table size.
- Each table end power unit includes (1) simplex, (1) USB-A+C, (1) AAP Blank (1) AAP w/ HDMI.
- Each table side power unit includes (1) simplex, (1) USB-A+C, (2) AAP Blank.
- 4-trac system, 4 wire, 2 circuit hardwire is standard.
- 72" soft plug infeed is available with 20amp plug. UL-Recognized.
- Chicago Code option: Each station includes one 15A 125V outlet and a 5.2A USB Type-A/Type-C Charger.
- No whips or cords provided for Chicago Code option.
- The recessed power area will be illuminated, dimmable, 2700K, 2.5w/ft.

+ Options:

- Specify WB for 12-inch diameter, non-supportive, wire chase base with access panel; add \$2098 to list price.
- Specify metal edge finish from standard powder coat colors.
 - (MRB) Resin Black
 - (MRBM) Resin Matte Black
 - (MRBAS) Resin Brushed Aluminum w/Steel Tint
 - (MRBZ) Resin Bronze
 - (MRSA) Resin Satin Aluminum
 - (MRTG) Resin Thunder Gray
 - (MRW) Resin White
- For (MPA) Polished Aluminum, See Customer Service for Custom Pricing. Longer lead times may apply.
- Specify SP For Soft Plug infeed; no price change.
- Specify CC for Chicago Code option; no price change.

Power Option Edge Detail

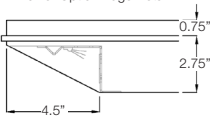

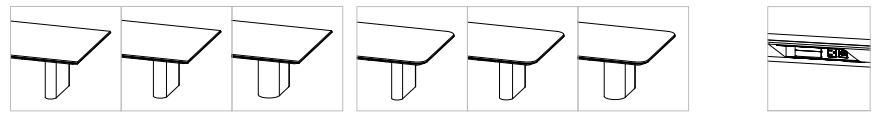

HPL Top, 29.9h ±

Base / Corner Detail Code

Power Options

Shape	sections	pcs	w	d	Seats	Prefix & Top Code	Square Corner Detail			Radius Corner Detail, 6-in Radius			1 per Seat	1 per 2 Seats + Ends		
							6.5-in Bases	8-in Bases	12.5-in Bases	6.5-in Bases	8-in Bases	12.5-in Bases				
	1	1	90	48	8	MTH... ...R6...	...S6 18462	...S8 18831	...S12 19200	...R6 19939	...R8 20337	...R12 20736	P 7786	P2 6130		
		1	96	48	8	...R7...	18719	19093	19468	20217	20620	21025	7786	6130		
	2	1	108	48	10	...R8...	19234	19619	20003	20773	21189	21603	9442	7786		
		1	120	52	10	...R9...	25391	25899	26407	27422	27971	28520	9442	7786		
		2	132	52	12	...R10...	25933	26452	26970	28008	28568	29128	11096	9442		
		2	144	52	12	...R11...	26476	27006	27535	28594	29166	29738	11096	9442		
		2	156	56	12	...R12...	28175	28739	29302	30429	31038	31646	11096	9442		
		2	168	56	14	...R13...	28746	29321	29896	31046	31667	32288	12754	11096		
		2	180	56	14	...R14...	29316	29902	30489	31661	32294	32928	12754	11096		
		2	192	60	16	...R15...	30434	31043	31651	32869	33526	34183	14410	12754		
		2	204	60	16	...R16...	34459	35148	35837	37216	37960	38704	14410	12754		
		2	216	60	18	...R17...	35058	35759	36460	37863	38620	39377	16064	14410		
		2	240	60	18	...R18...	36253	36978	37703	39153	39936	40719	16064	14410		
			1	1	120	52/40	10	...V6...	25837	26354	26870	27904	28462	29020	9442	7786
			2	2	132	52/40	12	...V7...	26389	26917	27445	28500	29070	29641	11096	9442
				2	144	52/40	12	...V8...	26941	27480	28019	29096	29678	30261	11096	9442
				2	156	56/44	12	...V9...	28671	29244	29818	30965	31584	32203	11096	9442
				2	168	56/44	14	...V10...	29251	29836	30421	31591	32223	32855	12754	11096
2	180			56/44	14	...V11...	29832	30429	31025	32219	32863	33507	12754	11096		
2	192			60/44	16	...V12...	30969	31588	32208	33447	34115	34785	14410	12754		
2	204			60/44	16	...V13...	35065	35766	36468	37870	38627	39385	14410	12754		
2	216			60/44	18	...V14...	35674	36387	37101	38528	39298	40069	16064	14410		
2	240			60/44	18	...V15...	36891	37629	38367	39842	40639	41436	16064	14410		
	1	1	90	48	10	...T6...	18787	19163	19538	—	—	—	9442	7786		
		1	96	48	10	...T7...	19049	19430	19811	—	—	—	9442	7786		
		1	108	52	10	...T8...	19572	19963	20355	—	—	—	9442	7786		
	2	1	120	54	12	...T9...	25837	26354	26870	—	—	—	11096	9442		
		2	132	54	12	...T10...	26389	26917	27445	—	—	—	11096	9442		
		2	144	54	14	...T11...	26941	27480	28019	—	—	—	12754	11096		
		2	156	60	14	...T12...	28671	29244	29818	—	—	—	12754	11096		
		2	168	60	14	...T13...	29251	29836	30421	—	—	—	12754	11096		
		2	180	60	16	...T14...	29832	30429	31025	—	—	—	14410	12754		
		2	192	60	16	...T15...	30969	31588	32208	—	—	—	14410	12754		
2	204	60	16	...T16...	35065	35766	36468	—	—	—	14410	12754				
2	216	60	18	...T17...	35674	36387	37101	—	—	—	16064	14410				
2	240	60	20	...T18...	36891	37629	38367	—	—	—	17720	16064				

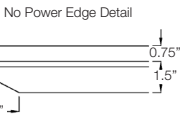

To include (1) Power per Seat, append P to end of product number and add list price.
 To include (1) Power per Every Two Seats + Ends, append P2 to end of product number and add list price.

> To Order:
 For product numbers, join the Prefix, Top Code and Base/Corner Detail Code; read across and down for price.
 Ex. For 90w 48d Rectangle HPL Top, Square Corners, 8-in Bases, w/ Power, Prod No. is MTHR6S8P; list price is \$26617.

! Notes:
 HPL Formica® 949 White
 Painted Subtop, Black
 Power option includes set number of power units. See Seats/Power Units for qty per table size.
 Each table end power unit includes (1) simplex, (1) USB-A+C, (1) AAP Blank (1) AAP w/ HDMI.
 Each table side power unit includes (1) simplex, (1) USB-A+C, (2) AAP Blank.
 4-trac system, 4 wire, 2 circuit hardwire is standard.
 72" soft plug infeed is available with 20amp plug. UL-Recognized.
 Chicago Code option: Each station includes one 15A 125V outlet and a 5.2A USB Type-A/Type-C Charger.
 No whips or cords provided for Chicago Code option.
 The recessed power area will be illuminated, dimmable, 2700K, 2.5w/ft.

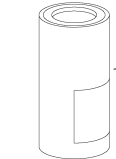

+ Options:
 Specify WB for 12-inch diameter, non-supportive, wire chase base with access panel; add \$2098 to list price.
 Specify metal edge finish from standard powder coat colors.
 (MRB) Resin Black (MRBZ) Resin Bronze (MRTG) Resin Thunder Gray
 (MRBM) Resin Matte Black (MRSA) Resin Satin Aluminum (MRW) Resin White
 (MRBAS) Resin Brushed Aluminum w/Steel Tint
 For (MPA) Polished Aluminum, See Customer Service for Custom Pricing. Longer lead times may apply.
 Specify SP For Soft Plug infeed; no price change.
 Specify CC for Chicago Code option; no price change.

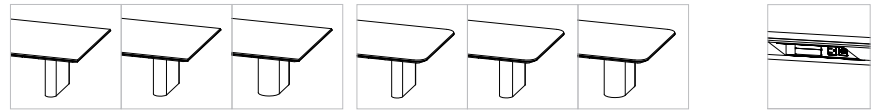

Solid Surface Top, 29.9h ±

Base / Corner Detail Code

Power Options

Shape	sections	pcs	w	d	Seats	Prefix & Top Code	Square Corner Detail			Radius Corner Detail, 6-in Radius			1 per Seat	1 per 2 Seats + Ends		
							6.5-in Bases	8-in Bases	12.5-in Bases	6.5-in Bases	8-in Bases	12.5-in Bases				
	1	1	90	48	8	MTS... ...R6...	...S6 20334	...S8 20741	...S12 21147	...R6 21961	...R8 22400	...R12 22839	P 7786	P2 6130		
		1	96	48	8	...R7...	20671	21084	21498	22325	22771	23218	7786	6130		
	2	1	108	48	10	...R8...	21345	21772	22199	23053	23514	23975	9442	7786		
		1	120	52	10	...R9...	28036	28597	29157	30279	30885	31490	9442	7786		
		2	132	52	12	...R10...	28752	29327	29902	31052	31673	32294	11096	9442		
		2	144	52	12	...R11...	29467	30056	30646	31824	32460	33098	11096	9442		
		2	156	56	12	...R12...	31393	32021	32649	33904	34583	35261	11096	9442		
		2	168	56	14	...R13...	32296	32942	33588	34880	35577	36275	12754	11096		
		2	180	56	14	...R14...	33052	33713	34374	35696	36410	37124	12754	11096		
		2	192	60	16	...R15...	34562	35253	35944	37327	38073	38820	14410	12754		
		2	204	60	16	...R16...	38943	39722	40501	42058	42900	43741	14050	12754		
		2	216	60	18	...R17...	39738	40533	41328	42917	43776	44634	16064	14410		
		2	240	60	18	...R18...	41330	42157	42983	44636	45530	46422	16064	14410		
			1	1	120	52/40	10	...V6...	28503	29073	29643	30783	31399	32014	9442	7786
				2	2	132	52/40	12	...V7...	29229	29814	30398	31567	32199	32830	11096
			2	2	144	52/40	12	...V8...	29954	30553	31152	32350	32997	33644	11096	9442
				2	156	56/44	12	...V9...	31912	32550	33188	34465	35154	35843	11096	9442
				2	168	56/44	14	...V10...	32825	33482	34138	35451	36161	36869	12754	11096
2	180			56/44	14	...V11...	33592	34264	34936	36279	37005	37731	12754	11096		
2	192			60/44	16	...V12...	35122	35824	36527	37932	38690	39449	14410	12754		
2	204			60/44	16	...V13...	39577	40369	41160	42743	43599	44453	14410	12754		
2	216			60/44	18	...V14...	40383	41191	41998	43614	44486	45358	16064	14410		
2	240			60/44	18	...V15...	41997	42837	43677	45357	46264	47171	16064	14410		
	1			1	90	48	10	...T6...	20674	21087	21501	—	—	—	9442	7786
				1	96	48	10	...T7...	21016	21436	21857	—	—	—	9442	7786
				1	108	52	10	...T8...	21699	22133	22567	—	—	—	9442	7786
				1	120	54	12	...T9...	28503	29073	29643	—	—	—	11096	9442
	2			2	132	54	12	...T10...	29229	29814	30398	—	—	—	11096	9442
		2	144	54	14	...T11...	29954	30553	31152	—	—	—	12754	11096		
		2	156	60	14	...T12...	31912	32550	33188	—	—	—	12754	11096		
		2	168	60	14	...T13...	32825	33482	34138	—	—	—	12754	11096		
		2	180	60	16	...T14...	33592	34264	34936	—	—	—	14410	12754		
		2	192	60	16	...T15...	35122	35824	36527	—	—	—	14410	12754		
		2	204	60	16	...T16...	39577	40369	41160	—	—	—	14410	12754		
		2	216	60	18	...T17...	40383	41191	41998	—	—	—	16064	14410		
		2	240	60	20	...T18...	41997	42837	43677	—	—	—	17720	16064		

No Power Edge Detail

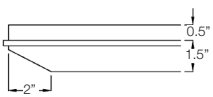

To include (1) Power per Seat, append P to end of product number and add list price.
 To include (1) Power per Every Two Seats + Ends, append P2 to end of product number and add list price.

> To Order:

For product numbers, join the Prefix, Top Code and Base/Corner Detail Code; read across and down for price.
 Ex. For 90w 48d Rectangle SS Top, Square Corners, 8-in Bases, w/ Power, Prod No. is MTSR6S8P; list price is \$28527.

! Notes:

- Solid Surface Avonite® Polaris Matte
- Painted Subtop, Black
- Power option includes set number of power units. See Seats/Power Units for qty per table size.
- Each table end power unit includes (1) simplex, (1) USB-A+C, (1) AAP Blank (1) AAP w/ HDMI.
- Each table side power unit includes (1) simplex, (1) USB-A+C, (2) AAP Blank.
- 4-trac system, 4 wire, 2 circuit hardwire is standard.
- 72" soft plug infeed is available with 20amp plug. UL-Recognized.
- Chicago Code option: Each station includes one 15A 125V outlet and a 5.2A USB Type-A/Type-C Charger.
- No whips or cords provided for Chicago Code option.
- The recessed power area will be illuminated, dimmable, 2700K, 2.5w/ft .

+ Options:

- Specify WB for 12-inch diameter, non-supportive, wire chase base with access panel; add \$2098 to list price.
- Specify metal edge finish from standard powder coat colors.
 - (MRB) Resin Black
 - (MRBM) Resin Matte Black
 - (MRBAS) Resin Brushed Aluminum w/Steel Tint
 - (MRBZ) Resin Bronze
 - (MRSA) Resin Satin Aluminum
 - (MRTG) Resin Thunder Gray
 - (MRW) Resin White
- For (MPA) Polished Aluminum, See Customer Service for Custom Pricing. Longer lead times may apply.
- Specify SP For Soft Plug infeed; no price change.
- Specify CC for Chicago Code option; no price change.



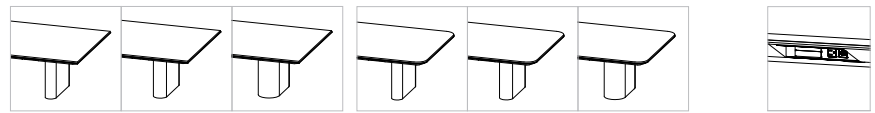

Fenix Top, 29.9h ±

Base / Corner Detail Code

Power Options

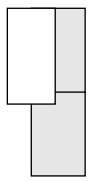
Shape	sections	pcs	w	d	Seats	Prefix & Top Code	Square Corner Detail			Radius Corner Detail, 6-in Radius			1 per Seat	1 per 2 Seats + Ends		
							6.5-in Bases	8-in Bases	12.5-in Bases	6.5-in Bases	8-in Bases	12.5-in Bases				
	1	1	90	48	8	MTF... ...R6...	...S6 20876	...S8 21294	...S12 21711	...R6 22546	...R8 22998	...R12 23448	P 7786	P2 6130		
			96	48	8	...R7... 21247	21672	22097	22947	23406	23865	7786	6130			
			108	48	10	...R8... 21993	22433	22873	23752	24228	24703	9442	7786			
	2	1	120	52	10	...R9... 28783	29359	29934	31086	31708	32329	9442	7786			
		2	132	52	12	...R10... 29572	30163	30755	31938	32576	33215	11096	9442			
		2	144	52	12	...R11... 30363	30970	31578	32792	33448	34104	11096	9442			
		2	156	56	12	...R12... 32363	33010	33658	34952	35651	36351	11096	9442			
		2	168	56	14	...R13... 33421	34089	34758	36095	36816	37539	12754	11096			
		2	180	56	14	...R14... 34258	34943	35628	36999	37738	38478	12754	11096			
		2	192	60	16	...R15... 35939	36658	37377	38814	39591	40367	14410	12754			
		2	204	60	16	...R16... 40407	41215	42023	43640	44512	45385	14410	12754			
		2	216	60	18	...R17... 41289	42115	42941	44592	45484	46376	16064	14410			
		2	240	60	18	...R18... 43052	43913	44774	46496	47426	48356	16064	14410			
		Video	1	1	120	52/40	10	...V6... 29250	29835	30420	31590	32222	32854	9442	7786	
					2	132	52/40	12	...V7... 30049	30650	31251	32453	33102	33751	11096	9442
					2	144	52/40	12	...V8... 30850	31467	32084	33318	33984	34651	11096	9442
			2	2	156	56/44	12	...V9... 32882	33540	34197	35513	36223	36933	11096	9442	
				2	168	56/44	14	...V10... 33950	34629	35308	36666	37399	38133	12754	11096	
2	180			56/44	14	...V11... 34798	35494	36190	37582	38334	39085	12754	11096			
2	192			60/44	16	...V12... 36499	37229	37959	39419	40207	40996	14410	12754			
2	204			60/44	16	...V13... 41041	41862	42683	44324	45211	46098	14410	12754			
2	216			60/44	18	...V14... 41934	42773	43611	45289	46195	47100	16064	14410			
2	240			60/44	18	...V15... 43719	44593	45468	47217	48160	49105	16064	14410			
Track	1			1	90	48	10	...T6... 21216	21640	22065	—	—	—	9442	7786	
					96	48	10	...T7... 21592	22024	22456	—	—	—	9442	7786	
					108	52	10	...T8... 22347	22794	23241	—	—	—	9442	7786	
	2			1	120	54	12	...T9... 29250	29835	30420	—	—	—	11096	9442	
				2	132	54	12	...T10... 30049	30650	31251	—	—	—	11096	9442	
		2	144	54	14	...T11... 30850	31467	32084	—	—	—	12754	11096			
		2	156	60	14	...T12... 32882	33540	34197	—	—	—	12754	11096			
		2	168	60	14	...T13... 33950	34629	35308	—	—	—	12754	11096			
		2	180	60	16	...T14... 34798	35494	36190	—	—	—	14410	12754			
		2	192	60	16	...T15... 36499	37229	37959	—	—	—	14410	12754			
		2	204	60	16	...T16... 41041	41862	42683	—	—	—	14410	12754			
		2	216	60	18	...T17... 41934	42773	43611	—	—	—	16064	14410			
		2	240	60	20	...T18... 43719	44593	45468	—	—	—	17720	16064			

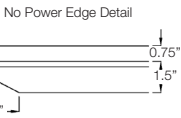

To include (1) Power per Seat, append P to end of product number and add list price.
 To include (1) Power per Every Two Seats + Ends, append P2 to end of product number and add list price.

> To Order:

For product numbers, join the Prefix, Top Code and Base/Corner Detail Code; read across and down for price.
 Ex. For 90w 48d Rectangle SS Top, Square Corners, 8-in Bases, w/ Power, Prod No. is MTSR6S8P; list price is \$29080.

! Notes:

- Fenix: 30 Bianco Alaska, 718 Grigio Londra, or 720 Nero Ingo
- Painted Subtop, Black
- Power option includes set number of power units. See Seats/Power Units for qty per table size.
- Each table end power unit includes (1) simplex, (1) USB-A+C, (1) AAP Blank (1) AAP w/ HDMI.
- Each table side power unit includes (1) simplex, (1) USB-A+C, (2) AAP Blank.
- 4-trac system, 4 wire, 2 circuit hardwire is standard.
- 72" soft plug infeed is available with 20amp plug. UL-Recognized.
- Chicago Code option: Each station includes one 15A 125V outlet and a 5.2A USB Type-A/Type-C Charger.
- No whips or cords provided for Chicago Code option.
- The recessed power area will be illuminated, dimmable, 2700K, 2.5w/ft.

+ Options:

- Specify WB for 12-inch diameter, non-supportive, wire chase base with access panel; add \$2098 to list price.
- Specify metal edge finish from standard powder coat colors.
 - (MRB) Resin Black (MRBZ) Resin Bronze (MRTG) Resin Thunder Gray
 - (MRBM) Resin Matte Black (MRSA) Resin Satin Aluminum (MRW) Resin White
 - (MRBAS) Resin Brushed Aluminum w/Steel Tint
- For (MPA) Polished Aluminum, See Customer Service for Custom Pricing. Longer lead times may apply.
- Specify SP For Soft Plug infeed; no price change.
- Specify CC for Chicago Code option; no price change.



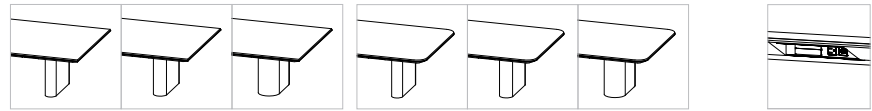

Back-Painted Glass Top, 29.9h ±

Base / Corner Detail Code

Power Options

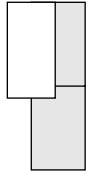
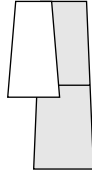
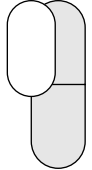
Shape	sections	pcs	w	d	Seats	Prefix & Top Code	Square Corner Detail			Radius Corner Detail, 6-in Radius			1 per Seat	1 per 2 Seats + Ends		
							6.5-in Bases	8-in Bases	12.5-in Bases	6.5-in Bases	8-in Bases	12.5-in Bases				
	1	1	90	48	8	MTG... ...R6...	...S6 24278	...S8 24764	...S12 25249	...R6 26220	...R8 26745	...R12 27269	P 7786	P2 6130		
		1	96	48	8	...R7...	24878	25376	25873	26868	27406	27943	7786	6130		
		1	108	48	10	...R8...	26078	26600	27121	28164	28728	29291	9442	7786		
	2	1	120	52	10	...R9...	33732	34407	35081	36431	37160	37887	9442	7786		
		2	132	52	12	...R10...	35016	35716	36417	37817	38573	39330	11096	9442		
		2	144	52	12	...R11...	36301	37027	37753	39205	39989	40773	11096	9442		
		2	156	56	12	...R12...	38796	39572	40348	41900	42738	43576	11096	9442		
		2	168	56	14	...R13...	40882	41700	42517	44153	45036	45918	12754	11096		
		2	180	56	14	...R14...	42251	43096	43941	45631	46544	47456	12754	11096		
		2	192	60	16	...R15...	45074	45975	46877	48680	49653	50627	14410	12754		
		2	204	60	16	...R16...	50113	51115	52118	54122	55204	56287	14410	12754		
		2	216	60	18	...R17...	51566	52597	53629	55691	56805	57919	16064	14410		
		2	240	60	18	...R18...	54472	55561	56651	58830	60006	61183	16064	14410		
			1	1	120	52/40	10	...V6...	34199	34883	35567	36935	37674	38412	9442	7786
			2	2	132	52/40	12	...V7...	35493	36203	36913	38332	39099	39866	11096	9442
2	144			52/40	12	...V8...	36788	37524	38260	39731	40526	41321	11096	9442		
2	156			56/44	12	...V9...	39315	40101	40888	42460	43309	44159	11096	9442		
2	168			56/44	14	...V10...	41411	42239	43067	44724	45618	46512	12754	11096		
2	180			56/44	14	...V11...	42791	43647	44503	46214	47139	48063	12754	11096		
2	192			60/44	16	...V12...	45634	46547	47459	49285	50271	51256	14410	12754		
2	204			60/44	16	...V13...	50747	51762	52777	54807	55903	56999	14410	12754		
2	216			60/44	18	...V14...	52211	53255	54299	56388	57515	58643	16064	14410		
2	240			60/44	18	...V15...	55139	56242	57345	59550	60741	61933	16064	14410		
	1	1	90	48	10	...T6...	24618	25110	25603	—	—	—	9442	7786		
	1	96	48	10	...T7...	25223	25727	26232	—	—	—	9442	7786			
	1	108	52	10	...T8...	26432	26961	27489	—	—	—	9442	7786			
	2	1	120	54	12	...T9...	34199	34883	35567	—	—	—	11096	9442		
		2	132	54	12	...T10...	35493	36203	36913	—	—	—	11096	9442		
		2	144	54	14	...T11...	36788	37524	38260	—	—	—	12754	11096		
		2	156	60	14	...T12...	39315	40101	40888	—	—	—	12754	11096		
		2	168	60	14	...T13...	41411	42239	43067	—	—	—	12754	11096		
		2	180	60	16	...T14...	42791	43647	44503	—	—	—	14410	12754		
		2	192	60	16	...T15...	45634	46547	47459	—	—	—	14410	12754		
2		204	60	16	...T16...	50747	51762	52777	—	—	—	14410	12754			
2	216	60	18	...T17...	52211	53255	54299	—	—	—	16064	14410				
2	240	60	20	...T18...	55139	56242	57345	—	—	—	17720	16064				

No Power Edge Detail

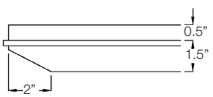

To include (1) Power per Seat, append P to end of product number and add list price.
 To include (1) Power per Every Two Seats + Ends, append P2 to end of product number and add list price.

> To Order:

For product numbers, join the Prefix, Top Code and Base/Corner Detail Code; read across and down for price.
 Ex. For 90w 48d Rectangle BP Glass Top, Square Corners, 8-in Bases, w/ Power, Prod No. is MTGR6S8P; list price is \$32550.

! Notes:

- Back-Painted Glass: S.BLK Black or S.BWT White
- Painted Subtop, Black
- Power option includes set number of power units. See Seats/Power Units for qty per table size.
- Each table end power unit includes (1) simplex, (1) USB-A+C, (1) AAP Blank (1) AAP w/ HDMI.
- Each table side power unit includes (1) simplex, (1) USB-A+C, (2) AAP Blank.
- 4-trac system, 4 wire, 2 circuit hardwire is standard.
- 72" soft plug infeed is available with 20amp plug. UL-Recognized.
- Chicago Code option: Each station includes one 15A 125V outlet and a 5.2A USB Type-A/Type-C Charger.
- No whips or cords provided for Chicago Code option.
- The recessed power area will be illuminated, dimmable, 2700K, 2.5w/ft.

+ Options:

- Specify WB for 12-inch diameter, non-supportive, wire chase base with access panel; add \$2098 to list price.
- Specify metal edge finish from standard powder coat colors.
 - (MRB) Resin Black (MRBZ) Resin Bronze (MRTG) Resin Thunder Gray
 - (MRBM) Resin Matte Black (MRSA) Resin Satin Aluminum (MRW) Resin White
 - (MRBAS) Resin Brushed Aluminum w/Steel Tint
- For (MPA) Polished Aluminum, See Customer Service for Custom Pricing. Longer lead times may apply.
- Specify SP For Soft Plug infeed; no price change.
- Specify CC for Chicago Code option; no price change.

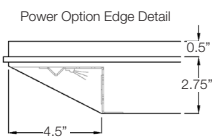

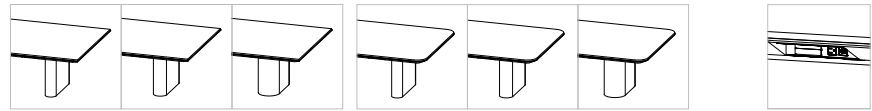

Acid-Etched Glass Top, 29.9h ±

Base / Corner Detail Code

Power Options

Shape	sections	pcs	w	d	Seats	Prefix & Top Code	Square Corner Detail			Radius Corner Detail, 6-in Radius			1 per Seat	1 per 2 Seats + Ends		
							6.5-in Bases	8-in Bases	12.5-in Bases	6.5-in Bases	8-in Bases	12.5-in Bases				
	1	1	90	48	8	MTJ... ...R6...	...S6	...S8	...S12	...R6	...R8	...R12	P	P2		
		1	96	48	8	...R7...	24881	25379	25876	26871	27409	27946	27946	7786	6130	
	2	1	108	48	10	...R8...	25521	26031	26542	27563	28113	28665	28665	7786	6130	
		1	120	52	10	...R9...	26802	27338	27874	28946	29525	30104	30104	9442	7786	
		2	132	52	12	...R10...	34604	35296	35988	37372	38120	38867	38867	9442	7786	
		2	144	52	12	...R11...	35975	36695	37414	38853	39631	40407	40407	11096	9442	
		2	156	56	12	...R12...	37347	38094	38841	40335	41142	41948	41948	11096	9442	
		2	168	56	14	...R13...	39929	40728	41526	43123	43986	44848	44848	11096	9442	
		2	180	56	14	...R14...	43064	43925	44787	46509	47439	48370	48370	12754	11096	
		2	192	60	16	...R15...	43660	44533	45406	47153	48096	49038	49038	12754	11096	
		2	192	60	16	...R15...	46684	47618	48551	50419	51427	52435	52435	14410	12754	
		2	204	60	16	...R16...	51823	52859	53896	55969	57088	58208	58208	14410	12754	
		2	216	60	18	...R17...	53376	54444	55511	57646	58800	59952	59952	16064	14410	
		2	240	60	18	...R18...	56483	57613	58742	61002	62222	63441	63441	16064	14410	
	1	1	120	52/40	10	...V6...	35071	35772	36474	37877	38634	39392	9442	7786		
		2	2	132	52/40	12	...V7...	36452	37181	37910	39368	40155	40943	11096	9442	
	2	2	144	52/40	12	...V8...	37834	38591	39347	40861	41678	42495	42495	11096	9442	
		2	156	56/44	12	...V9...	40448	41257	42066	43684	44558	45431	45431	11096	9442	
		2	168	56/44	14	...V10...	43593	44465	45337	47080	48022	48964	48964	12754	11096	
		2	180	56/44	14	...V11...	44200	45084	45968	47736	48691	49645	49645	12754	11096	
		2	192	60/44	16	...V12...	47244	48189	49134	51024	52044	53065	53065	14410	12754	
		2	204	60/44	16	...V13...	52457	53506	54555	56654	57786	58919	58919	14410	12754	
		2	216	60/44	18	...V14...	54021	55101	56182	58343	59509	60677	60677	16064	14410	
		2	240	60/44	18	...V15...	57150	58293	59436	61722	62956	64191	64191	16064	14410	
			1	1	90	48	10	...T6...	25221	25725	26230	—	—	—	9442	7786
				1	96	48	10	...T7...	25866	26383	26901	—	—	—	9442	7786
2	1		108	52	10	...T8...	27156	27699	28242	—	—	—	9442	7786		
	1		120	54	12	...T9...	35071	35772	36474	—	—	—	11096	9442		
	2		132	54	12	...T10...	36452	37181	37910	—	—	—	11096	9442		
	2		144	54	14	...T11...	37834	38591	39347	—	—	—	12754	11096		
	2		156	60	14	...T12...	40448	41257	42066	—	—	—	12754	11096		
	2		168	60	14	...T13...	43593	44465	45337	—	—	—	12754	11096		
	2		180	60	16	...T14...	44200	45084	45968	—	—	—	14410	12754		
	2		192	60	16	...T15...	47244	48189	49134	—	—	—	14410	12754		
2	204	60	16	...T16...	52457	53506	54555	—	—	—	14410	12754				
2	216	60	18	...T17...	54021	55101	56182	—	—	—	16064	14410				
2	240	60	20	...T18...	57150	58293	59436	—	—	—	17720	16064				

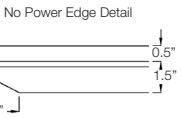

To include (1) Power per Seat, append P to end of product number and add list price.
 To include (1) Power per Every Two Seats + Ends, append P2 to end of product number and add list price.

> To Order:
 For product numbers, join the Prefix, Top Code and Base/Corner Detail Code; read across and down for price.
 Ex. For 90w 48d Rectangle AE Glass Top, Square Corners, 8-in Bases, w/ Power, Prod No. is MTJR6S8P; list price is \$33165.

! Notes:
 Acid-Etched Glass: GAB Black or GAW White
 Painted Subtop, Black
 Power option includes set number of power units. See Seats/Power Units for qty per table size.
 Each table end power unit includes (1) simplex, (1) USB-A+C, (1) AAP Blank (1) AAP w/ HDMI.
 Each table side power unit includes (1) simplex, (1) USB-A+C, (2) AAP Blank.
 4-trac system, 4 wire, 2 circuit hardwire is standard.
 72" soft plug infeed is available with 20amp plug. UL-Recognized.
 Chicago Code option: Each station includes one 15A 125V outlet and a 5.2A USB Type-A/Type-C Charger.
 No whips or cords provided for Chicago Code option.
 The recessed power area will be illuminated, dimmable, 2700K, 2.5w/ft.

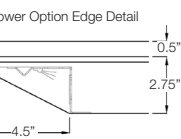

+ Options:
 Specify WB for 12-inch diameter, non-supportive, wire chase base with access panel; add \$2098 to list price.
 Specify metal edge finish from standard powder coat colors.
 (MRB) Resin Black (MRBZ) Resin Bronze (MRTG) Resin Thunder Gray
 (MRBM) Resin Matte Black (MRSA) Resin Satin Aluminum (MRW) Resin White
 (MRBAS) Resin Brushed Aluminum w/Steel Tint
 For (MPA) Polished Aluminum, See Customer Service for Custom Pricing. Longer lead times may apply.
 Specify SP For Soft Plug infeed; no price change.
 Specify CC for Chicago Code option; no price change.



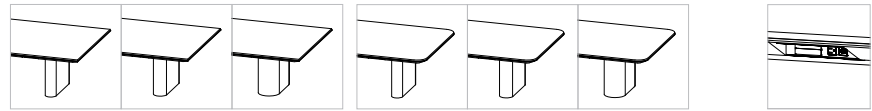

Marble Top, 29.9h ±

Base / Corner Detail Code

Power Options

Shape	sections	pcs	w	d	Seats	Prefix & Top Code	Square Corner Detail			Radius Corner Detail, 6-in Radius			1 per Seat	1 per 2 Seats + Ends		
							6.5-in Bases	8-in Bases	12.5-in Bases	6.5-in Bases	8-in Bases	12.5-in Bases				
	1	1	90	48	8	MTM... ...R6...	...S6	...S8	...S12	...R6	...R8	...R12	P	P2		
		1	96	48	8	...R7...	34150	34833	35516	36882	37620	38357	7786	6130		
	2	1	108	48	10	...R8...	35408	36116	36824	38241	39005	39770	7786	6130		
		1	120	52	10	...R9...	37924	38682	39441	40958	41777	42596	9442	7786		
		2	132	52	12	...R10...	47992	48952	49912	51831	52868	53905	9442	7786		
		2	144	52	12	...R11...	50702	51716	52730	54758	55853	56948	11096	9442		
		2	156	56	12	...R12...	53413	54481	55550	57686	58839	59994	11096	9442		
		2	168	56	14	...R13...	57335	58482	59628	61922	63161	64398	11096	9442		
		2	180	56	14	...R14...	62382	63630	64877	67373	68720	70067	12754	11096		
		2	192	60	16	...R15...	65286	66592	67897	70509	71919	73329	12754	11096		
		2	192	60	16	...R15...	71401	72829	74257	77113	78655	80198	14410	12754		
		2	204	60	16	...R16...	78085	79647	81208	84332	86019	87705	14410	12754		
		2	216	60	18	...R17...	81183	82807	84430	87678	89432	91184	16064	14410		
		2	240	60	18	...R18...	87380	89128	90875	94370	96258	98145	16064	14410		
			1	1	120	52/40	10	...V6...	48459	49428	50397	52336	53382	54429	9442	7786
				2	2	132	52/40	12	...V7...	51179	52203	53226	55273	56379	57484	11096
			2	2	144	52/40	12	...V8...	53900	54978	56056	58212	59376	60540	11096	9442
				2	156	56/44	12	...V9...	57854	59011	60168	62482	63732	64981	11096	9442
2	168			56/44	14	...V10...	62911	64169	65427	67944	69303	70661	12754	11096		
2	180			56/44	14	...V11...	65826	67143	68459	71092	72514	73936	12754	11096		
2	192			60/44	16	...V12...	71961	73400	74839	77718	79272	80826	14410	12754		
2	204			60/44	16	...V13...	78719	80293	81868	85017	86716	88417	14410	12754		
2	216			60/44	18	...V14...	81828	83465	85101	88374	90142	91909	16064	14410		
2	240			60/44	18	...V15...	88047	89808	91569	95091	96993	98895	16064	14410		
	1			1	90	48	10	...T6...	34793	35489	36185	—	—	—	9442	7786
				1	96	48	10	...T7...	36056	36777	37498	—	—	—	9442	7786
				1	108	52	10	...T8...	38581	39353	40124	—	—	—	9442	7786
				1	120	54	12	...T9...	48762	49737	50712	—	—	—	11096	9442
	2			2	132	54	12	...T10...	51482	52512	53541	—	—	—	11096	9442
		2	144	54	14	...T11...	54203	55287	56371	—	—	—	12754	11096		
		2	156	60	14	...T12...	58157	59320	60483	—	—	—	12754	11096		
		2	168	60	14	...T13...	63214	64478	65743	—	—	—	12754	11096		
		2	180	60	16	...T14...	66129	67452	68774	—	—	—	14410	12754		
		2	192	60	16	...T15...	72264	73709	75155	—	—	—	14410	12754		
		2	204	60	16	...T16...	79022	80602	82183	—	—	—	14410	12754		
		2	216	60	18	...T17...	82131	83774	85416	—	—	—	16064	14410		
		2	240	60	20	...T18...	88350	90117	91884	—	—	—	17720	16064		

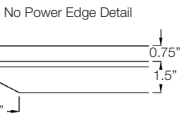

To include (1) Power per Seat, append P to end of product number and add list price.
 To include (1) Power per Every Two Seats + Ends, append P2 to end of product number and add list price.

> To Order:
 For product numbers, join the Prefix, Top Code and Base/Corner Detail Code; read across and down for price.
 Ex. For 90w 48d Rectangle Marble Top, Square Corners, 8-in Bases, w/ Power, Prod No. is MTMR6S8P; list price is \$42619.

! Notes:
 Marble: Carrara
 Painted Subtop, Black
 Power option includes set number of power units. See Seats/Power Units for qty per table size.
 Each table end power unit includes (1) simplex, (1) USB-A+C, (1) AAP Blank (1) AAP w/ HDMI.
 Each table side power unit includes (1) simplex, (1) USB-A+C, (2) AAP Blank.
 4-trac system, 4 wire, 2 circuit hardwire is standard.
 72" soft plug infeed is available with 20amp plug. UL-Recognized.
 Chicago Code option: Each station includes one 15A 125V outlet and a 5.2A USB Type-A/Type-C Charger.
 No whips or cords provided for Chicago Code option.
 The recessed power area will be illuminated, dimmable, 2700K, 2.5w/ft.

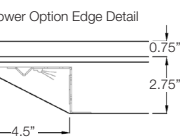

+ Options:
 Specify WB for 12-inch diameter, non-supportive, wire chase base with access panel; add \$2098 to list price.
 Specify metal edge finish from standard powder coat colors.
 (MRB) Resin Black (MRBZ) Resin Bronze (MRTG) Resin Thunder Gray
 (MRBM) Resin Matte Black (MRSA) Resin Satin Aluminum (MRW) Resin White
 (MRBAS) Resin Brushed Aluminum w/Steel Tint
 For (MPA) Polished Aluminum, See Customer Service for Custom Pricing. Longer lead times may apply.
 Specify SP For Soft Plug infeed; no price change.
 Specify CC for Chicago Code option; no price change.



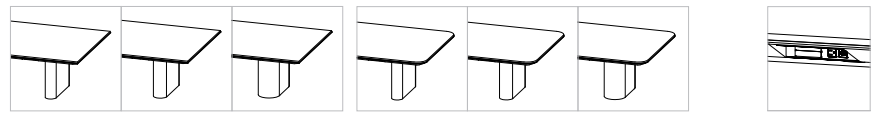

Quartz Top, 29.9h ±

Base / Corner Detail Code

Power Options

Shape	sections	pcs	w	d	Seats	Prefix & Top Code	Square Corner Detail			Radius Corner Detail, 6-in Radius			1 per Seat	1 per 2 Seats + Ends		
							6.5-in Bases	8-in Bases	12.5-in Bases	6.5-in Bases	8-in Bases	12.5-in Bases				
	1	1	90	48	8	MTQ... ...R6...	...S6 33522	...S8 34192	...S12 34863	...R6 36204	...R8 36927	...R12 37652	P 7786	P2 6130		
		1	96	48	8	...R7...	34738	35433	36128	37517	38268	39018	7786	6130		
	2	1	108	48	10	...R8...	37170	37913	38657	40144	40946	41750	9442	7786		
		1	120	52	10	...R9...	47083	48025	48966	50850	51867	52883	9442	7786		
		2	132	52	12	...R10...	49703	50697	51691	53679	54753	55826	11096	9442		
		2	144	52	12	...R11...	52324	53370	54417	56510	57640	58770	11096	9442		
		2	156	56	12	...R12...	56154	57277	58400	60646	61859	63072	11096	9442		
		2	168	56	14	...R13...	61012	62232	63452	65893	67211	68528	12754	11096		
		2	180	56	14	...R14...	63820	65096	66373	68926	70304	71683	12754	11096		
		2	192	60	16	...R15...	69725	71120	72514	75303	76810	78315	14410	12754		
		2	204	60	16	...R16...	76304	77830	79356	82408	84056	85704	14410	12754		
		2	216	60	18	...R17...	82897	84555	86213	89529	91319	93110	16064	14410		
		2	240	60	18	...R18...	85285	86991	88696	92108	93950	95792	16064	14410		
			1	1	120	52/40	10	...V6...	47550	48501	49452	51354	52381	53408	9442	7786
				2	2	132	52/40	12	...V7...	50180	51184	52187	54194	55279	56362	11096
			2	2	144	52/40	12	...V8...	52811	53867	54923	57036	58176	59317	11096	9442
				2	156	56/44	12	...V9...	56673	57806	58940	61207	62430	63655	11096	9442
				2	168	56/44	14	...V10...	61541	62772	64003	66464	67794	69123	12754	11096
2	180			56/44	14	...V11...	64360	65647	66934	69509	70899	72289	12754	11096		
2	192			60/44	16	...V12...	70285	71691	73096	75908	77426	78944	14410	12754		
2	204			60/44	16	...V13...	76938	78477	80016	83093	84755	86417	14410	12754		
2	216			60/44	18	...V14...	83542	85213	86884	90225	92030	93835	16064	14410		
2	240			60/44	18	...V15...	85952	87671	89390	92828	94685	96541	16064	14410		
	1			1	90	48	10	...T6...	34165	34848	35532	—	—	—	9442	7786
				1	96	48	10	...T7...	35386	36094	36801	—	—	—	9442	7786
		1	108	52	10	...T8...	37827	38584	39340	—	—	—	9442	7786		
		1	120	54	12	...T9...	47853	48810	49767	—	—	—	11096	9442		
	2	2	132	54	12	...T10...	50483	51493	52502	—	—	—	11096	9442		
		2	144	54	14	...T11...	53114	54176	55239	—	—	—	12754	11096		
		2	156	60	14	...T12...	56976	58116	59255	—	—	—	12754	11096		
		2	168	60	14	...T13...	61844	63081	64318	—	—	—	12754	11096		
		2	180	60	16	...T14...	64663	65956	67250	—	—	—	14410	12754		
		2	192	60	16	...T15...	70588	72000	73412	—	—	—	14410	12754		
		2	204	60	16	...T16...	77241	78786	80331	—	—	—	14410	12754		
		2	216	60	18	...T17...	83845	85522	87199	—	—	—	16064	14410		
2	240	60	20	...T18...	86255	87980	89705	—	—	—	17720	16064				

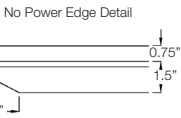

To include (1) Power per Seat, append P to end of product number and add list price.
 To include (1) Power per Every Two Seats + Ends, append P2 to end of product number and add list price.

> To Order:
 For product numbers, join the Prefix, Top Code and Base/Corner Detail Code; read across and down for price.
 Ex. For 90w 48d Rectangle Quartz Top, Square Corners, 8-in Bases, w/ Power, Prod No. is MTQR6S8P; list price is \$41978.

! Notes:
 Quartz: Cambria® Signature and Classic (all colors); quote required for all other offerings.
 Painted Subtop, Black
 Power option includes set number of power units. See Seats/Power Units for qty per table size.
 Each table end power unit includes (1) simplex, (1) USB-A+C, (1) AAP Blank (1) AAP w/ HDMI.
 Each table side power unit includes (1) simplex, (1) USB-A+C, (2) AAP Blank.
 4-trac system, 4 wire, 2 circuit hardwire is standard.
 72" soft plug infeed is available with 20amp plug. UL-Recognized.
 Chicago Code option: Each station includes one 15A 125V outlet and a 5.2A USB Type-A/Type-C Charger.
 No whips or cords provided for Chicago Code option.
 The recessed power area will be illuminated, dimmable, 2700K, 2.5w/ft.

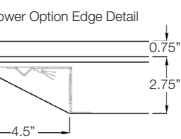

+ Options:
 Specify WB for 12-inch diameter, non-supportive, wire chase base with access panel; add \$2098 to list price.
 Specify metal edge finish from standard powder coat colors.
 (MRB) Resin Black (MRBZ) Resin Bronze (MRTG) Resin Thunder Gray
 (MRBM) Resin Matte Black (MRSA) Resin Satin Aluminum (MRW) Resin White
 (MRBAS) Resin Brushed Aluminum w/Steel Tint
 For (MPA) Polished Aluminum, See Customer Service for Custom Pricing. Longer lead times may apply.
 Specify SP For Soft Plug infeed; no price change.
 Specify CC for Chicago Code option; no price change.



