

ADJUSTABLE
HEIGHT RANGE:
29.9" TO 48.4" HIGH

NOTES:

- * ADJUSTABLE HEIGHT INCLUDES 1" GAP AT ALL PINCH POINTS
- * PULLS - #900 (MRB) RESIN BLACK

POWER OPTION
N/A

EDGE PROFILE
SQUARE SELF EDGE, 1.5" TH

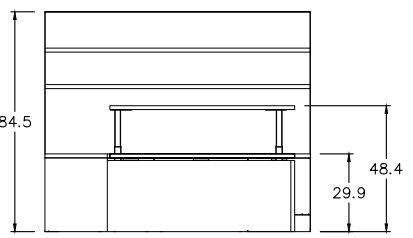
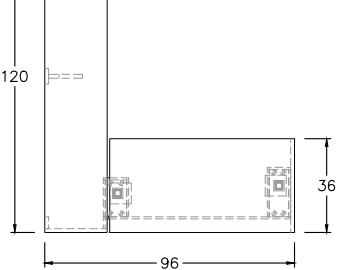
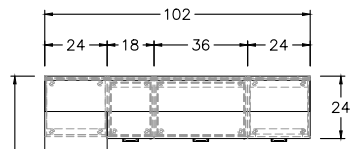
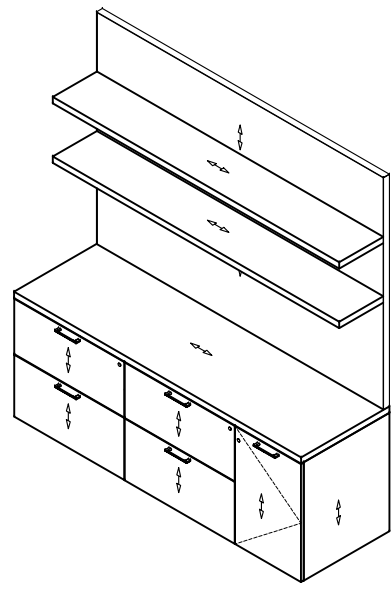
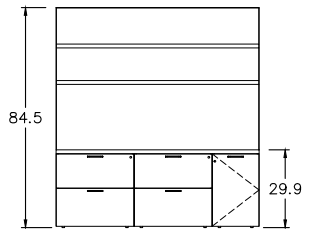
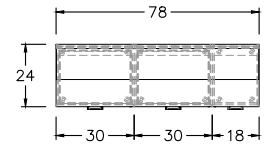
CSR: TRISH	
CREATED: 05/15/24	JES
REVISION DATE: 05/16/24	JES
PDF: 051524-ISO (2)	
E:\TUOHY\SALES ENGINEERING\SALES DRAWINGS\TJS\051524	

PROJECT:	XEROX
TAG:	OFFICE 03-109

FINISHES:
VENEER: WOOD1
PAINT:
LAMINATE:
STONE:
GLASS:
SOLID SURFACE:
FABRIC:



This drawing is for visual purposes only. Dimensions are nominal.
This drawing is the property of Tuohy Furniture Corporation.
Unauthorized reproduction is unlawful.
We reserve the sole right to manufacture and distribute any design
represented within this document.