

PRICING & SPECIFICATION GUIDE
Danza Collection

May 1, 2023

TUOHY



Casegoods: **Danza**

Vertical Cadence	AD2
Drawer Layouts	AD3
Desk Shells	AD4
Desk Returns	AD6
Runoffs	AD8
Computer Corners	AD17
Wall Hung Credenza, AdjHt	AD19
Pedestals	AD21
Mobile Pedestals	AD23
Modesty Panels	AD24
Base Panels	AD25
Top Supports	AD25
Tops	AD26
Top Dividers	AD30
Hutches	AD31
Task Lights for Hutches	AD33
Wall Panels	AD34
Shelves	AD37
Towers Lateral Files	AD38
Towers 60.5	AD39
Towers 72.5h	AD42
Towers 84.5h	AD45

Vertical Cadence

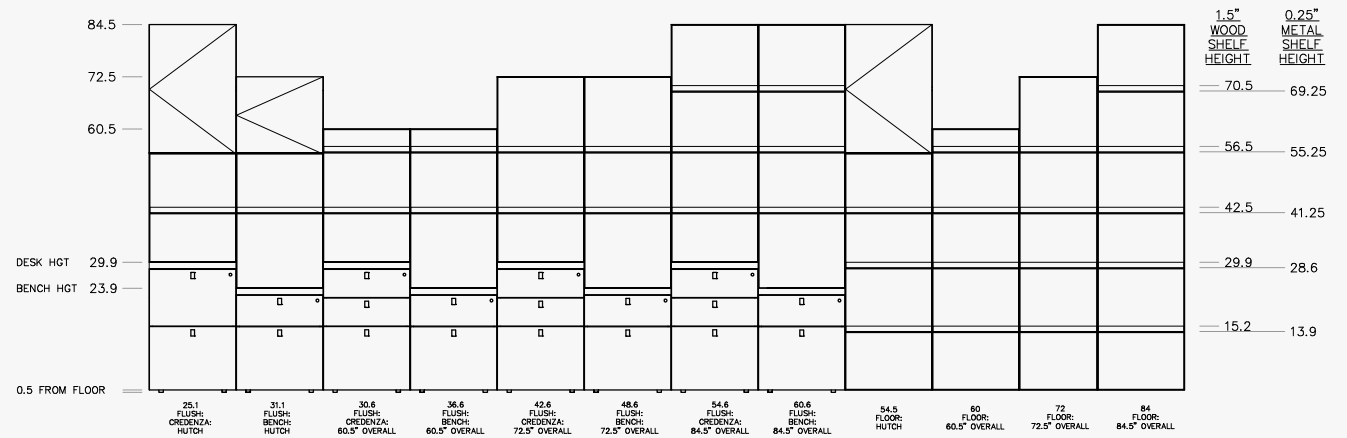

Drawer Layouts: Plan View

Slides: Under-Mount

Mobile 20d
Drawers 18d

16w 18w 24w

Pedestal Units 20d
Drawers 18d

16w 18w 20w 24w 30w 36w

Pedestal Units 24d
Drawers 21d

16w 18w 20w 24w 30w 36w

Peds 30d & 36d
Dwr 27d Dwr 15d

18w w-varies
Ht.Adj.

Box Drawer w Divider

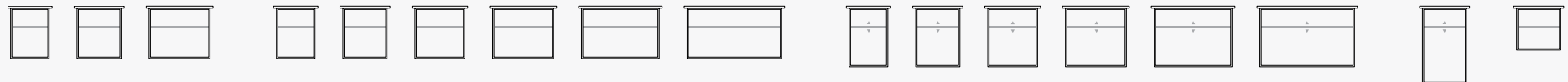

Lateral Filing

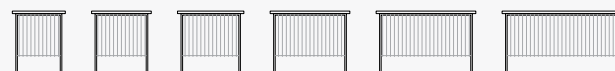
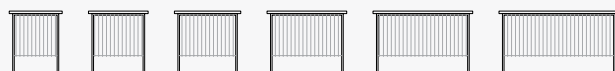
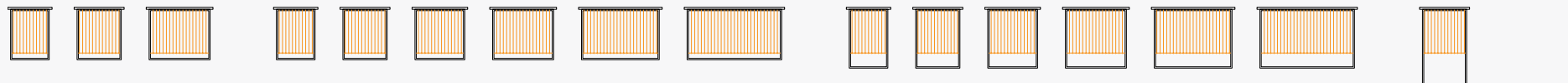

Front-to-Back Filing

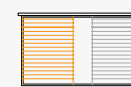

- Legal Filing
- Letter Filing
- Adjustable Divider

DRAWER CONSTRUCTION

A fine point for a quality casegood product is the inner drawer construction. Each TUOHY casegood offers you uncompromised excellence in this area as well. Drawer boxes are constructed with dovetail joinery for maximum durability. The drawer face is mounted separately to this box (i.e., five-sided construction) to maintain integrity.

Drawer bottoms are dadoed on all four sides. Slides for box drawers are rated at 100 pounds static load capacity; slides for file drawers are rated at a heavy duty 150 static load capacity. All slides are concealed, full extension and soft-close.

Box drawers have a removable divider, adjustable when depicted (±). File drawers have file frames for filing laterally or front-to-back, as depicted above. For Drawers for Lap Area, Drawer Pencil Tray, and Locks: See the Introduction/Terms-Options section of the Master Price List, page 12.

Desk Shell 29.9h

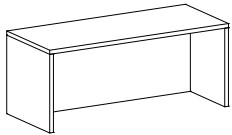
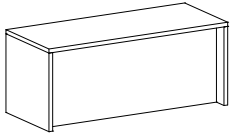

Description	Product No.	Spec Code	List \$	Spec Code	List \$	Spec Code	List \$	Spec Code	List \$
		HPL Top		Wood1 Top		Solid Surface Top		OcuWrite Top	
Desk 60w 30d	DZA?6030	HP	2730	W1	3009	SS	3897	AG	4345
Desk 60w 36d	DZA?6036	HP	2955	W1	3229	SS	4296	AG	4876
Desk 66w 30d	DZA?6630	HP	2833	W1	3113	SS	4089	AG	4604
Desk 66w 36d	DZA?6636	HP	3068	W1	3342	SS	4514	AG	5178
• Desk 72w 30d	DZA?7230	HP	2939	W1	3216	SS	4279	AG	4863
Desk 72w 36d	DZA?7236	HP	3183	W1	3453	SS	4729	AG	5475
Desk 78w 30d	DZA?7830	HP	3043	W1	3316	SS	4469	AG	5121
Desk 78w 36d	DZA?7836	HP	3297	W1	3566	SS	4949	AG	5775
Desk 84w 30d	DZA?8430	HP	3147	W1	3419	SS	4662	AG	5379
Desk 84w 36d	DZA?8436	HP	3411	W1	3677	SS	5166	AG	6074

! Notes:

Top finishes are listed above; specify Wood1 finish for elements below worksurface.

All desk pedestals are 18w wide.

Pedestals are 24d on 30d shell.

Pedestals are 30d on 36d shell.

Glass tops have metal edges; MRBAS, Metal Resin Brushed Aluminum w/ Steel Tint; HPL tops have PVC edges; all other tops are self-edged.

Standard HPL top material is Formica 949 White Matte.

Standard Solid Surface material is Avonite Polar White, Matte.

OcuWrite Back-Painted Glass color: O.BWT White.

Acrylic faces are Stylelite Arctic White standard.

Modesty panel is set back 5.25 inches.

Locks included.

+ Options:

For 30d Desk Shell:

For shell only, omit the ? in the 4th digit.

To add B/B/F left, append 4th digit from ? to A; and add \$2017.

To add B/B/F right, append 4th digit from ? to B; and add \$2017.

To add F/F left, append 4th digit from ? to C; and add \$1857.

To add F/F right, append 4th digit from ? to D; and add \$1857.

To add B/B/F left - F/F right, append 4th digit from ? to E; and add \$3877.

To add F/F left - B/B/F right, append 4th digit from ? to F; and add \$3877.

To add B/B/F left - B/B/F right, append 4th digit from ? to G; and add \$4033.

To add F/F left - F/F right append 4th digit from ? to H; and add \$3716.

For 36d Desk Shell:

To add B/B/F left, append 4th digit from ? to A; and add \$2280.

To add B/B/F right, append 4th digit from ? to B; and add \$2280.

To add F/F left, append 4th digit from ? to C; and add \$2064.

To add F/F right, append 4th digit from ? to D; and add \$2064.

To add B/B/F left - F/F right, append 4th digit from ? to E; and add \$4345.

To add F/F left - B/B/F right, append 4th digit from ? to F; and add \$4345.

To add B/B/F left - B/B/F right, append 4th digit from ? to G; and add \$4558.

To add F/F left F/F right, append 4th digit from ? to H; and add \$4132.

To add metal edge to Wood, Laminate or Acrylic Solid Surface tops, add ME to the end of Spec code, and price that correlates to top size from metal edge table.

Metal edge table is located just below Top options.

To add acrylic faces, append A to end of Product Code, and add \$459 per pedestal.

Pull finish is standard MRBAS, Brushed Aluminum w/Steel tint; for polished specify MPA, Polished Aluminum.

Desk Shell 29.9-48.4h
Adjustable Height

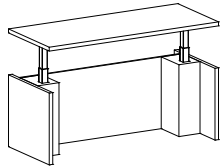
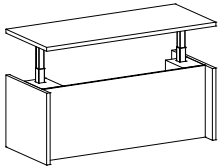

Description	Product No.	Spec Code	List \$	Spec Code	List \$	Spec Code	List \$	Spec Code	List \$
		HPL Top		Wood1 Top		Solid Surface Top		OcuWrite Top	
Desk 60w 30d	DZB?6030	HP	5545	W1	5826	SS	6715	AG	7160
Desk 60w 36d	DZB?6036	HP	5770	W1	6047	SS	7112	AG	7692
Desk 66w 30d	DZB?6630	HP	5651	W1	5929	SS	6905	AG	7418
Desk 66w 36d	DZB?6636	HP	5886	W1	6159	SS	7328	AG	7993
• Desk 72w 30d	DZB?7230	HP	5755	W1	6031	SS	7095	AG	7679
Desk 72w 36d	DZB?7236	HP	6000	W1	6272	SS	7547	AG	8293
Desk 78w 30d	DZB?7830	HP	5859	W1	6134	SS	7287	AG	7937
Desk 78w 36d	DZB?7836	HP	6114	W1	6382	SS	7764	AG	8590
Desk 84w 30d	DZB?8430	HP	5964	W1	6235	SS	7477	AG	8194
Desk 84w 36d	DZB?8436	HP	6229	W1	6494	SS	7982	AG	8890

! Notes:

Top finishes are listed above; specify Wood1 finish for elements below worksurface.

All desk pedestals are 18w wide.

Pedestals are 24d on 30d shell.

Pedestals are 30d on 36d shell.

Glass tops have metal edges; MRBAS, Metal Resin Brushed Aluminum w/ Steel Tint; HPL tops have PVC edges; all other tops are self-edged.

Standard HPL top material is Formica 949 White Matte.

Standard Solid Surface material is Avonite Polaris White, Matte.

OcuWrite Back-Painted Glass color: O.BWT White.

Acrylic faces are Stylelite Arctic White standard.

Modesty panel is set back 5.25 inches.

Locks Included.

+ Options:

For shell only, omit the ? in the 4th digit.

For 30d Desk Shell:

To add B/B/F left, append 4th digit from ? to A; and add \$1857.

To add B/B/F right, append 4th digit from ? to B; and add \$1857.

To add B/B/F left - B/B/F right, append 4th digit from ? to G; and add \$3876.

For 36d Desk Shell:

To add B/B/F left, append 4th digit from ? to A; and add \$2064.

To add B/B/F right, append 4th digit from ? to B; and add \$2064.

To add B/B/F left - B/B/F right, append 4th digit from ? to G; and add \$4345.

To add metal edge to Wood, Laminate or Acrylic Solid Surface tops, add ME to the end of Spec code, and price that correlates to top size from metal edge table.

Metal edge table is located just below Top options.

To add acrylic faces, append A to end of Product Code, and add \$459per pedestal.

Pull finish is standard MRBAS, Brushed Aluminum w/Steel tint; for polished specify MPA, Polished Aluminum.

Specify White, Silver or Black for height adjustable leg color.

Desk Return Shell 29.9h

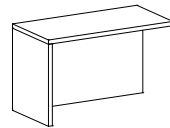
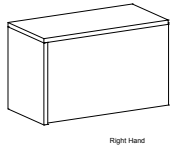

Description	Product No.	Spec Code	List \$	Spec Code	List \$	Spec Code	List \$	Spec Code	List \$
1.5 End Panel/Mod Panel		HPL Top		Wood1 Top		Solid Surface Top		OcuWrite Top	
• Return 48w 24d	DZC?4824	HP	1928	W1	2151	SS	2718	AG	3033
Return 54w 24d	DZC?5424	HP	2030	W1	2250	SS	2889	AG	3258
Return 60w 24d	DZC?6024	HP	2134	W1	2351	SS	3060	AG	3483

! Notes:

Top finishes are listed above; specify Wood1 finish for elements below worksurface.

All return pedestals are 18w x 20d.

Glass tops have metal edges; MRBAS, Metal Resin Brushed Aluminum w/ Steel Tint; HPL tops have PVC edges; all other tops are self-edged.

Standard HPL top material is Formica 949 White Matte.

Standard Solid Surface material is Avonite Polaris White, Matte.

OcuWrite Back-Painted Glass color: O.BWT White.

Acrylic faces are Stylelite Arctic White standard.

Modesty panel is recessed 1.5-in.

Specify L, for left; or R, for right hand runoff. Place at the end of Product number.

Locks Included.

+ Options:

For 24d Shell:

For shell only, omit the ? in the 4th digit.

To add B/B/F left, append 4th digit from ? to E; and add \$2017.

To add B/B/F right, append 4th digit from ? to F; and add \$2017.

To add F/F left, append 4th digit from ? to G; and add \$1857.

To add F/F right, append 4th digit from ? to H; and add \$1857.

To add metal edge to Wood, Laminate or Acrylic Solid Surface tops, add ME to the end of Spec code, and price that correlates to top size from metal edge table.

Metal edge table is located just below Top options.

To add acrylic faces, append A to end of Product Code, and add \$459.

Pull finish is standard MRBAS, Brushed Aluminum w/Steel tint; for polished specify MPA, Polished Aluminum.

Desk Return Shell 29.9-48.4h
Height Adjustable

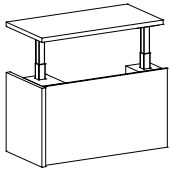

Right Hand

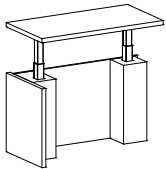

Left Hand

Description	Product No.	Spec Code	List \$	Spec Code	List \$	Spec Code	List \$	Spec Code	List \$
1.5 End Panel/Mod Panel		HPL Top		Wood1 Top		Solid Surface Top		OcuWrite Top	
• Runoff 48w 24d	DZD?4824	HP	4717	W1	4936	SS	5504	AG	5820
Runoff 54w 24d	DZD?5424	HP	4816	W1	5037	SS	5675	AG	6045
Runoff 60w 24d	DZD?6024	HP	4919	W1	5137	SS	5845	AG	6271

! Notes:

Top finishes are listed above; specify Wood1 finish for elements below worksurface.

Height adjustable legs will be inside plinths.

Glass tops have metal edges; MRBAS, Metal Resin Brushed Aluminum w/ Steel Tint; HPL tops have PVC edges; all other tops are self-edged.

Standard HPL top material is Formica 949 White Matte.

Standard Solid Surface material is Avonite Polaris White, Matte.

OcuWrite Back-Painted Glass color: O.BWT White.

Specify L for left, or R for right hand runoff. Place at the end of Product number.

Mod Panel set back 1.5 inches.

Locks included.

+ Options:

To add metal edge to Wood, Laminate or Acrylic Solid Surface tops, add ME to the end of Spec code, and price that correlates to top size from metal edge table.

Metal edge table is located just below Top options.

Pull finish is standard MRBAS, Brushed Aluminum w/Steel tint; for polished specify MPA, Polished Aluminum.

Specify White, Silver or Black for height adjustable leg color.

Runoff with Leg, 29.9h
Straight Leg



Runoff with Leg, 29.9h
Loop Leg

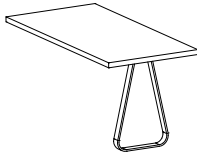

Description	Product No.	Spec Code	List \$	Spec Code	List \$	Spec Code	List \$	Spec Code	List \$
		HPL Top		Wood1 Top		Solid Surface Top		OcuWrite Top	
Runoff 48w 30d	DZES4830	HP	2065	W1	2460	SS	3482	AG	3906
Runoff 48w 36d	DZES4836	HP	2147	W1	2540	SS	3699	AG	4233
Runoff 54w 30d	DZES5430	HP	2116	W1	2511	SS	3618	AG	4112
Runoff 54w 36d	DZES5436	HP	2209	W1	2597	SS	3864	AG	4478
• Runoff 60w 30d	DZES6030	HP	2167	W1	2559	SS	3754	AG	4314
Runoff 60w 36d	DZES6036	HP	2269	W1	2654	SS	4028	AG	4723
Runoff 66w 30d	DZES6630	HP	2218	W1	2606	SS	3891	AG	4518
Runoff 66w 36d	DZES6636	HP	2329	W1	2712	SS	4192	AG	4967
Runoff 72w 30d	DZES7230	HP	2269	W1	2654	SS	4028	AG	4723
Runoff 72w 36d	DZES7236	HP	2390	W1	2770	SS	4356	AG	5213
		HPL Top		Wood1 Top		Solid Surface Top		OcuWrite Top	
Runoff 48w 30d	DZEC4830	HP	2206	W1	2601	SS	3621	AG	4044
Runoff 48w 36d	DZEC4836	HP	2286	W1	2678	SS	3840	AG	4372
Runoff 54w 30d	DZEC5430	HP	2254	W1	2649	SS	3756	AG	4248
Runoff 54w 36d	DZEC5436	HP	2346	W1	2735	SS	4004	AG	4616
• Runoff 60w 30d	DZEC6030	HP	2306	W1	2697	SS	3894	AG	4453
Runoff 60w 36d	DZEC6036	HP	2408	W1	2794	SS	4169	AG	4863
Runoff 66w 30d	DZEC6630	HP	2357	W1	2745	SS	4031	AG	4657
Runoff 66w 36d	DZEC6636	HP	2469	W1	2851	SS	4331	AG	5106
Runoff 72w 30d	DZEC7230	HP	2408	W1	2794	SS	4169	AG	4863
Runoff 72w 36d	DZEC7236	HP	2528	W1	2909	SS	4496	AG	5351

! Notes:

Top finishes are listed above.
 Glass tops have metal edges; MRBAS, Metal Resin Brushed Aluminum w/ Steel Tint; HPL tops have PVC edges; all other tops are self-edged.
 Standard HPL top material is Formica 949 White Matte.
 Standard Solid Surface material is Avonite Polaris White, Matte.
 OcuWrite Back-Painted Glass color: O.BWT White.

+ Options:

Standard leg colors are MRTG: Thunder Grey, MRW: White, MRB: Black, MRSA: Satin Aluminum.
 Optional: MPA: Polished Aluminum, MRBAS: Brushed Aluminum w/Steel Tint.
 Straight Leg; Polished Aluminum add \$1059, Brushed Aluminum w/Steel Tint add \$268.
 Continuous Loop; Polished Aluminum add \$1248, Brushed Aluminum w/Steel Tint add \$315.
 To add metal edge to Wood, Laminate or Acrylic Solid Surface tops, add ME to the end of Spec code, and price that correlates to top size from metal edge table.
 Metal edge table is located just below Top options.

Runoff, Short EndPnl & Mod 29.9h

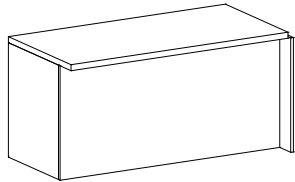

Right Hand

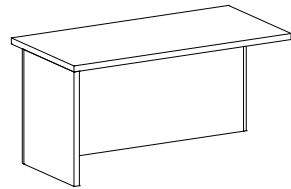

Left Hand

Description	Product No.	Spec Code	List \$	Spec Code	List \$	Spec Code	List \$	Spec Code	List \$
		HPL Top		Wood1 Top		Solid Surface Top		OcuWrite Top	
Runoff 48w 30d	DZEA4830	HP	2033	W1	2250	SS	2960	AG	3382
Runoff 48w 36d	DZEA4836	HP	2163	W1	2376	SS	3227	AG	3758
Runoff 54w 30d	DZEA5430	HP	2082	W1	2298	SS	3095	AG	3587
Runoff 54w 36d	DZEA5436	HP	2224	W1	2434	SS	3392	AG	4004
• Runoff 60w 30d	DZEA6030	HP	2135	W1	2346	SS	3233	AG	3793
Runoff 60w 36d	DZEA6036	HP	2284	W1	2491	SS	3554	AG	4248
Runoff 66w 30d	DZEA6630	HP	2185	W1	2394	SS	3369	AG	3995
Runoff 66w 36d	DZEA6636	HP	2345	W1	2548	SS	3719	AG	4494
Runoff 72w 30d	DZEA7230	HP	2235	W1	2443	SS	3507	AG	4201
Runoff 72w 36d	DZEA7236	HP	2405	W1	2606	SS	3884	AG	4740

! Notes:

Top finishes are listed above.

1.5-in End Panel.

Glass tops have metal edges; MRBAS, Metal Resin Brushed Aluminum w/ Steel Tint; HPL tops have PVC edges; all other tops are self-edged.

Standard HPL top material is Formica 949 White Matte.

Standard Solid Surface material is Avonite Polaris White, Matte.

OcuWrite Back-Painted Glass color: O.BWT White.

Modesty panel is set back 5.25 inches.

+ Options:

Specify Wood1 finish for End Panel and Modesty.

Specify L, for left; or R, for right hand runoff. Place at the end of Product number.

To add metal edge to Wood, Laminate or Acrylic Solid Surface tops, add ME to the end of Spec code, and price that correlates to top size from metal edge table.

Metal edge table is located just below Top options.

Runoff, EndPnl & Modesty 29.9h

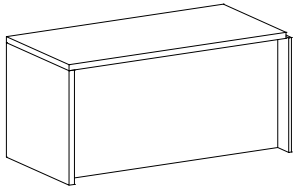

Right Hand

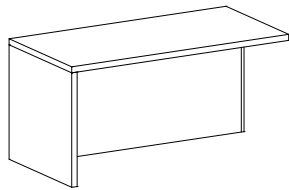

Left Hand

Description	Product No.	Spec Code	List \$	Spec Code	List \$	Spec Code	List \$	Spec Code	List \$
		HPL Top		Wood1 Top		Solid Surface Top		OcuWrite Top	
Runoff 48w 30d	DZEB4830	HP	2082	W1	2300	SS	3008	AG	3432
Runoff 48w 36d	DZEB4836	HP	2212	W1	2426	SS	3277	AG	3807
Runoff 54w 30d	DZEB5430	HP	2134	W1	2347	SS	3145	AG	3636
Runoff 54w 36d	DZEB5436	HP	2272	W1	2483	SS	3441	AG	4055
• Runoff 60w 30d	DZEB6030	HP	2183	W1	2395	SS	3281	AG	3841
Runoff 60w 36d	DZEB6036	HP	2334	W1	2541	SS	3605	AG	4299
Runoff 66w 30d	DZEB6630	HP	2234	W1	2443	SS	3419	AG	4045
Runoff 66w 36d	DZEB6636	HP	2394	W1	2599	SS	3770	AG	4544
Runoff 72w 30d	DZEB7230	HP	2284	W1	2491	SS	3554	AG	4248
Runoff 72w 36d	DZEB7236	HP	2454	W1	2655	SS	3932	AG	4789

! Notes:

Top finishes are listed above.
1.5-in End Panel.

Glass tops have metal edges; MRBAS, Metal Resin Brushed Aluminum w/ Steel Tint; HPL tops have PVC edges; all other tops are self-edged.

Standard HPL top material is Formica 949 White Matte.

Standard Solid Surface material is Avonite Polaris White, Matte.

OcuWrite Back-Painted Glass color: O.BWT White.

Modesty panel is set back 5.25 inches.

+ Options:

Specify Wood1 finish for End Panel and Modesty.

Specify L, for left; or R, for right hand runoff. Place at the end of Product number.

To add metal edge to Wood, Laminate or Acrylic Solid Surface tops, add ME to the end of Spec code, and price that correlates to top size from metal edge table.

Metal edge table is located just below Top options.

Runoff, Ped & Modesty 29.9h

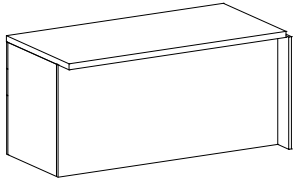

Right Hand

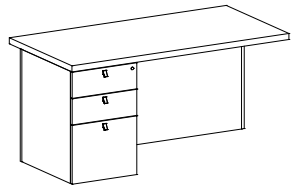

Left Hand

Description	Product No.	Spec Code	List \$	Spec Code	List \$	Spec Code	List \$	Spec Code	List \$
		HPL Top		Wood1 Top		Solid Surface Top		OcuWrite Top	
Runoff 48w 30d	DZF?4830	HP	1786	W1	2004	SS	2712	AG	3135
Runoff 48w 36d	DZF?4836	HP	1867	W1	2080	SS	2932	AG	3463
Runoff 54w 30d	DZF?5430	HP	1836	W1	2051	SS	2850	AG	3341
Runoff 54w 36d	DZF?5436	HP	1927	W1	2138	SS	3095	AG	3709
Runoff 60w 30d	DZF?6030	HP	1886	W1	2100	SS	2986	AG	3545
Runoff 60w 36d	DZF?6036	HP	1988	W1	2195	SS	3259	AG	3953
Runoff 66w 30d	DZF?6630	HP	1937	W1	2147	SS	3123	AG	3749
Runoff 66w 36d	DZF?6636	HP	2050	W1	2252	SS	3424	AG	4198
Runoff 72w 30d	DZF?7230	HP	1988	W1	2195	SS	3259	AG	3953
Runoff 72w 36d	DZF?7236	HP	2109	W1	2310	SS	3587	AG	4444

! Notes:

Top finishes are listed above; specify Wood1 finish for elements below worksurface.

All runoff pedestals are 18w.

Pedestals are 24d on 30d shell.

Pedestals are 30d on 36d shell.

Glass tops have metal edges; MRBAS, Metal Resin Brushed Aluminum w/ Steel Tint; HPL tops have PVC edges; all other tops are self-edged.

Standard HPL top material is Formica 949 White Matte.

Standard Solid Surface material is Avonite Polaris White, Matte.

OcuWrite Back-Painted Glass color: O.BWT White.

Acrylic faces are Stylelite Arctic White standard.

Modesty panel is set back 5.25 inches.

Locks included.

+ Options:

For 30d Runoff Shell:

To add B/B/F left, append 4th digit to E and add \$2017.

To add B/B/F right, append 4th digit to F and add \$2017.

To add F/F left, append 4th digit to G and add \$1857.

To add F/F right, append 4th digit to H and add \$1857.

For 36d Runoff Shell:

To add B/B/F left, append 4th digit to E and add \$2280.

To add B/B/F right, append 4th digit to F and add \$2280.

To add F/F left, append 4th digit to G and add \$2064.

To add F/F right, append 4th digit to H and add \$2064.

To add acrylic faces, append A to end of Product Code, and add \$459.

To add metal edge to Wood, Laminate or Acrylic Solid Surface tops, add ME to the end of Spec code, and price that correlates to top size from metal edge table.

Metal edge table is located just below Top options.

Pull finish is standard MRBAS, Brushed Aluminum w/Steel tint; for polished specify MPA, Polished Aluminum.

Runoff Shell, Short End Pnl 29.9-48.4h
Height Adjustable

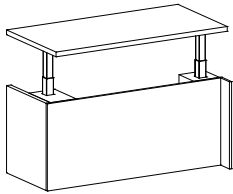

Right Hand

Description	Product No.	Spec Code	List \$	Spec Code	List \$	Spec Code	List \$	Spec Code	List \$
		HPL Top		Wood1 Top		Solid Surface Top		OcuWrite Top	
Runoff 48w 30d	DZEE4830	HP	4888	W1	5105	SS	5815	AG	6237
Runoff 48w 36d	DZEE4836	HP	5018	W1	5232	SS	6082	AG	6613
Runoff 54w 30d	DZEE5430	HP	4937	W1	5153	SS	5950	AG	6443
Runoff 54w 36d	DZEE5436	HP	5079	W1	5290	SS	6246	AG	6859
Runoff 60w 30d	DZEE6030	HP	4990	W1	5201	SS	6088	AG	6647
Runoff 60w 36d	DZEE6036	HP	5139	W1	5348	SS	6409	AG	7103
Runoff 66w 30d	DZEE6630	HP	5040	W1	5249	SS	6224	AG	6850
Runoff 66w 36d	DZEE6636	HP	5200	W1	5404	SS	6574	AG	7349
Runoff 72w 30d	DZEE7230	HP	5090	W1	5298	SS	6362	AG	7056
Runoff 72w 36d	DZEE7236	HP	5261	W1	5463	SS	6739	AG	7596

Runoff Shell, End Pnl 29.9-48.4h
Height Adjustable

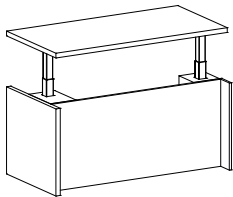

Right Hand

Description	Product No.	Spec Code	List \$	Spec Code	List \$	Spec Code	List \$	Spec Code	List \$
		HPL Top		Wood1 Top		Solid Surface Top		OcuWrite Top	
Runoff 48w 30d	DZEF4830	HP	4937	W1	5154	SS	5863	AG	6287
Runoff 48w 36d	DZEF4836	HP	5067	W1	5280	SS	6132	AG	6662
Runoff 54w 30d	DZEF5430	HP	4989	W1	5203	SS	6000	AG	6491
Runoff 54w 36d	DZEF5436	HP	5127	W1	5338	SS	6296	AG	6910
• Runoff 60w 30d	DZEF6030	HP	5038	W1	5250	SS	6136	AG	6696
Runoff 60w 36d	DZEF6036	HP	5189	W1	5396	SS	6460	AG	7154
Runoff 66w 30d	DZEF6630	HP	5089	W1	5298	SS	6274	AG	6900
Runoff 66w 36d	DZEF6636	HP	5249	W1	5454	SS	6624	AG	7399
Runoff 72w 30d	DZEF7230	HP	5139	W1	5348	SS	6409	AG	7103
Runoff 72w 36d	DZEF7236	HP	5309	W1	5510	SS	6788	AG	7644

! Notes:

Top finishes are listed above; specify Wood1 finish for elements below worksurface.
 Glass tops have metal edges; MRBAS, Metal Resin Brushed Aluminum w/ Steel Tint; HPL tops have PVC edges; all other tops are self-edged.
 Standard HPL top material is Formica 949 White Matte.
 Standard Solid Surface material is Avonite Polaris White, Matte.
 Mitre folded plinth construction.
 1.5-in End Panel.
 OcuWrite Back-Painted Glass color: O.BWT White.

+ Options:

Specify Wood1 finish for End Panel and Modesty.
 Specify L for left, or R for right hand runoff. Place at the end of product number.
 Specify White, Silver or Black for height adjustable leg color.
 To add metal edge to Wood, Laminate or Acrylic Solid Surface tops, add ME to the end of Spec code, and price that correlates to top size from metal edge table.
 Metal edge table is located just below Top options.

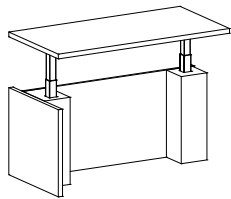

Left Hand

Runoff, Plinth-Mod-Plinth 29.9-48.4h
Height Adjustable

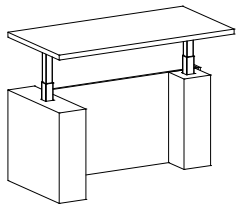
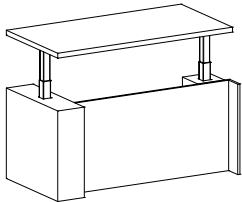

Description	Product No.	Spec Code	List \$	Spec Code	List \$	Spec Code	List \$	Spec Code	List \$
		HPL Top		Wood1 Top		Solid Surface Top		OcuWrite Top	
Runoff 48w 30d	DZEG4830	HP	5220	W1	5438	SS	6147	AG	6571
Runoff 48w 36d	DZEG4836	HP	5397	W1	5611	SS	6462	AG	6994
Runoff 54w 30d	DZEG5430	HP	5271	W1	5485	SS	6283	AG	6775
Runoff 54w 36d	DZEG5436	HP	5457	W1	5669	SS	6627	AG	7240
• Runoff 60w 30d	DZEG6030	HP	5321	W1	5534	SS	6421	AG	6977
Runoff 60w 36d	DZEG6036	HP	5521	W1	5727	SS	6791	AG	7484
Runoff 66w 30d	DZEG6630	HP	5370	W1	5582	SS	6557	AG	7182
Runoff 66w 36d	DZEG6636	HP	5581	W1	5783	SS	6955	AG	7728
Runoff 72w 30d	DZEG7230	HP	5422	W1	5629	SS	6694	AG	7388
Runoff 72w 36d	DZEG7236	HP	5641	W1	5842	SS	7119	AG	7975

! Notes:

Top finishes are listed above; specify Wood1 finish for elements below worksurface.
 Glass tops have metal edges; MRBAS, Metal Resin Brushed Aluminum w/ Steel Tint; HPL tops have PVC edges; all other tops are self-edged.
 Standard HPL top material is Formica 949 White Matte.
 Standard Solid Surface material is Avonite Polaris White, Matte.
 Mitre folded plinth construction.
 OcuWrite Back-Painted Glass color: O.BWT White.

+ Options:

Specify Wood1 finish for End Panel and Modesty.
 Specify L, for left; or R, for right hand runoff. Place at the end of product number.
 Specify White, Silver or Black for height adjustable leg color.
 To add metal edge to Wood, Laminate or Acrylic Solid Surface tops, add ME to the end of Spec code, and price that correlates to top size from metal edge table.
 Metal edge table is located just below Top options.

Runoff, Ped & Plinth 29.9-48.4h
Height Adjustable

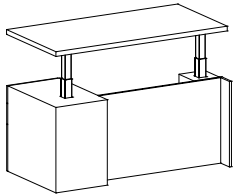

Right Hand

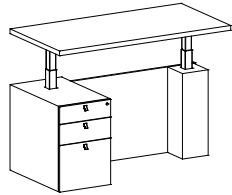

Left Hand

Description	Product No.	HPL Top		Wood1 Top		Solid Surface Top		OcuWrite Top	
		Spec Code	List \$	Spec Code	List \$	Spec Code	List \$	Spec Code	List \$
Runoff 48w 30d	DZG?4830	HP	5933	W1	6149	SS	6859	AG	5952
Runoff 48w 36d	DZG?4836	HP	6335	W1	6548	SS	7399	AG	6335
Runoff 54w 30d	DZG?5430	HP	5984	W1	6199	SS	6995	AG	6002
Runoff 54w 36d	DZG?5436	HP	6395	W1	6605	SS	7562	AG	6395
Runoff 60w 30d	DZG?6030	HP	6034	W1	6246	SS	7133	AG	6053
Runoff 60w 36d	DZG?6036	HP	6456	W1	6662	SS	7727	AG	6455
Runoff 66w 30d	DZG?6630	HP	6084	W1	6294	SS	7269	AG	6105
Runoff 66w 36d	DZG?6636	HP	6516	W1	6721	SS	7892	AG	6515
Runoff 72w 30d	DZG?7230	HP	6135	W1	6343	SS	7407	AG	6154
Runoff 72w 36d	DZG?7236	HP	6577	W1	6779	SS	8057	AG	6575

! Notes:

Mitre folded pedestal and plinth construction.

Top finishes are listed above; specify Wood1 finish for elements below worksurface.

All runoff pedestals are 18w 20d.

Glass tops have metal edges; MRBAS, Metal Resin Brushed Aluminum w/ Steel Tint; HPL tops have PVC edges; all other tops are self-edged.

Standard HPL top material is Formica 949 White Matte.

Standard Solid Surface material is Avonite Polaris White, Matte.

OcuWrite Back-Painted Glass color: O.BWT White.

Acrylic faces are Stylelite Arctic White standard.

Locks included.

+ Options:

To add B/B/F left, append 4th digit to A and add \$2017.

To add B/B/F right, append 4th digit to B and add \$2017.

Specify Wood1 finish for End Panel and Modesty.

Specify White, Silver or Black for height adjustable leg color.

To add metal edge to Wood, Laminate or Acrylic Solid Surface tops, add ME to the end of Spec code, and price that correlates to top size from metal edge table.

Metal edge table is located just below Top options.

To add acrylic faces, append A to end of Product Code, and add \$459.

Pull finish is standard MRBAS, Brushed Aluminum w/Steel tint; for polished specify MPA, Polished Aluminum.

Runoff, T-Leg 29.9-48.4h
Height Adjustable

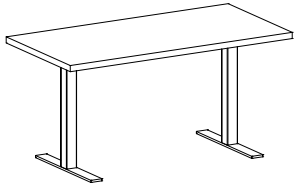

Description	Product No.	Spec Code	List \$	Spec Code	List \$	Spec Code	List \$	Spec Code	List \$
		HPL Top		Wood1 Top		Solid Surface Top		OcuWrite Top	
Runoff 48w 30d	DZEH4830	HP	3793	W1	4187	SS	5208	AG	5631
Runoff 48w 36d	DZEH4836	HP	3872	W1	4264	SS	5425	AG	5959
Runoff 54w 30d	DZEH5430	HP	3842	W1	4235	SS	5343	AG	5835
Runoff 54w 36d	DZEH5436	HP	3932	W1	4322	SS	5590	AG	6202
• Runoff 60w 30d	DZEH6030	HP	3893	W1	4285	SS	5480	AG	6041
Runoff 60w 36d	DZEH6036	HP	3994	W1	4380	SS	5755	AG	6448
Runoff 66w 30d	DZEH6630	HP	3943	W1	4332	SS	5618	AG	6243
Runoff 66w 36d	DZEH6636	HP	4055	W1	4437	SS	5917	AG	6693
Runoff 72w 30d	DZEH7230	HP	3994	W1	4380	SS	5755	AG	6448
Runoff 72w 36d	DZEH7236	HP	4115	W1	4496	SS	6082	AG	6938

! Notes:

Standard HPL top material is Formica 949 White Matte.

Standard Solid Surface material is Avonite Polaris White, Matte.

OcuWrite Back-Painted Glass color: O.BWT White.

Top finishes are listed above; specify Wood1 finish for elements below worksurface where applicable.

Plinth bases are mitre folded construction. Available on 3 leg desk only.

Plinth bases are priced in Wood1 options.

+ Options:

Specify leg color: White, Black or Silver.

Specify L for left; or R for right hand runoff. Place at the end of product number.

Runoff, Plinth 29.9-48.4h
Height Adjustable

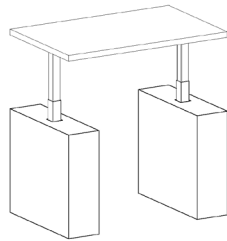
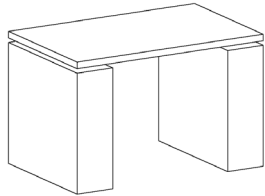

Description	Product No.	Spec Code	List \$	Spec Code	List \$	Spec Code	List \$	Spec Code	List \$
		HPL Top		Wood1 Top		Solid Surface Top		OcuWrite Top	
Runoff 48w 30d	DZEP4830	HP	6296	W1	6578	SS	7584	AG	8661
Runoff 48w 36d	DZEP4836	HP	6563	W1	6834	SS	7856	AG	8932
Runoff 54w 30d	DZEP5430	HP	6413	W1	6691	SS	7731	AG	8943
Runoff 54w 36d	DZEP5436	HP	6657	W1	6928	SS	8003	AG	9215
• Runoff 60w 30d	DZEP6030	HP	6508	W1	6785	SS	7878	AG	9225
Runoff 60w 36d	DZEP6036	HP	6750	W1	7017	SS	8140	AG	9487
Runoff 66w 30d	DZEP6630	HP	6602	W1	6873	SS	8016	AG	9497
Runoff 66w 36d	DZEP6636	HP	6683	W1	7111	SS	8282	AG	9764
Runoff 72w 30d	DZEP7230	HP	6696	W1	6966	SS	8159	AG	9773
Runoff 72w 36d	DZEP7236	HP	6986	W1	7205	SS	8435	AG	10050

! Notes:

- Standard HPL top material is Formica 949 White Matte.
- Standard Solid Surface material is Avonite Polaris White, Matte.
- OcuWrite Back-Painted Glass color: O.BWT White.
- Top finishes are listed above; specify Wood1 finish for elements below worksurface where applicable.
- Plinth bases are mitre folded construction.
- Plinth bases are priced in Wood1 options.

+ Options:

- Specify leg color: White, Black or Silver.

Computer Corner, T Legs 29.9-48.4h
Height Adjustable

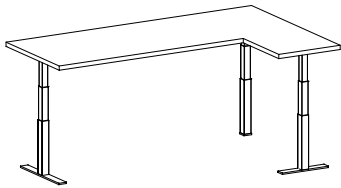

Description	Product No.	Spec Code	List \$	Spec Code	List \$
		HPL Top		Wood1 Top	
Corner 72w 30d x 48w 20d	DZEJ72304820	HP	4751	W1	5124
Corner 72w 36d x 48w 24d	DZEJ72364824	HP	4925	W1	5290
Corner 78w 30d x 48w 20d	DZEJ78304820	HP	4801	W1	5171
Corner 78w 36d x 48w 24d	DZEJ78364824	HP	4984	W1	5349
Corner 84w 30d x 48w 20d	DZEJ84304820	HP	4851	W1	5220
Corner 84w 36d x 48w 24d	DZEJ84364824	HP	5047	W1	5406
Corner 96w 30d x 48w 20d	DZEJ96304820	HP	4953	W1	5314
Corner 96w 36d x 48w 24d	DZEJ96364824	HP	5167	W1	5522
		HPL Top		Wood1 Top	
Corner 72w 30d x 54w 20d	DZEJ72305420	HP	4783	W1	5156
Corner 72w 36d x 54w 24d	DZEJ72365424	HP	4964	W1	5328
Corner 78w 30d x 54w 20d	DZEJ78305420	HP	4834	W1	5203
Corner 78w 36d x 54w 24d	DZEJ78365424	HP	5026	W1	5385
Corner 84w 30d x 54w 20d	DZEJ84305420	HP	4884	W1	5251
Corner 84w 36d x 54w 24d	DZEJ84365424	HP	5088	W1	5443
Corner 96w 30d x 54w 20d	DZEJ96305420	HP	4984	W1	5349
Corner 96w 36d x 54w 24d	DZEJ96365424	HP	5209	W1	5559
		HPL Top		Wood1 Top	
Corner 72w 30d x 60w 20d	DZEJ72306020	HP	4816	W1	5186
Corner 72w 36d x 60w 24d	DZEJ72366024	HP	5006	W1	5367
Corner 78w 30d x 60w 20d	DZEJ78306020	HP	4869	W1	5236
Corner 78w 36d x 60w 24d	DZEJ78366024	HP	5067	W1	5424
Corner 84w 30d x 60w 20d	DZEJ84306020	HP	4919	W1	5284
Corner 84w 36d x 60w 24d	DZEJ84366024	HP	5127	W1	5483
Corner 96w 30d x 60w 20d	DZEJ96306020	HP	5019	W1	5380
• Corner 96w 36d x 60w 24d	DZEJ96366024	HP	5249	W1	5598

! Notes:

Standard HPL top material is Formica 949 White Matte.
 Standard Solid Surface material is Avonite Polaris White, Matte.
 OcuWrite Back-Painted Glass color: O.BWT White.
 Top finishes are listed above; specify Wood1 finish for elements below worksurface where applicable.
 Plinth bases are mitre folded construction. Available on 3 leg desk only.
 Plinth bases are priced in Wood1 options.

+ Options:

Specify leg color: White, Black or Silver.
 Specify L for left; or R for right hand runoff. Place at the end of product number.

Computer Corner, Plinth Bases 29.9-48.4h
Height Adjustable

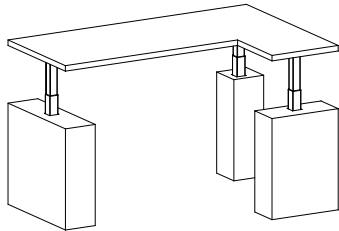

Description	Product No.	Spec Code	List \$	Spec Code	List \$
		HPL Top		Wood1 Top	
• Corner 72w 30d x 48w 20d	DZEK72304820	HP	7165	W1	7538
Corner 72w 36d x 48w 24d	DZEK72364824	HP	7340	W1	7703
Corner 78w 30d x 48w 20d	DZEK78304820	HP	7214	W1	7584
Corner 78w 36d x 48w 24d	DZEK78364824	HP	7399	W1	7761
Corner 84w 30d x 48w 20d	DZEK84304820	HP	7265	W1	7632
Corner 84w 36d x 48w 24d	DZEK84364824	HP	7460	W1	7818
Corner 96w 30d x 48w 20d	DZEK96304820	HP	7367	W1	7728
Corner 96w 36d x 48w 24d	DZEK96364824	HP	7582	W1	7935
		HPL Top		Wood1 Top	
Corner 72w 30d x 54w 20d	DZEK72305420	HP	7198	W1	7571
Corner 72w 36d x 54w 24d	DZEK72365424	HP	7378	W1	7743
Corner 78w 30d x 54w 20d	DZEK78305420	HP	7247	W1	7616
Corner 78w 36d x 54w 24d	DZEK78365424	HP	7440	W1	7800
Corner 84w 30d x 54w 20d	DZEK84305420	HP	7299	W1	7666
Corner 84w 36d x 54w 24d	DZEK84365424	HP	7501	W1	7857
Corner 96w 30d x 54w 20d	DZEK96305420	HP	7399	W1	7761
Corner 96w 36d x 54w 24d	DZEK96365424	HP	7621	W1	7974
		HPL Top		Wood1 Top	
Corner 72w 30d x 60w 20d	DZEK72306020	HP	7230	W1	7601
Corner 72w 36d x 60w 24d	DZEK72366024	HP	7418	W1	7781
Corner 78w 30d x 60w 20d	DZEK78306020	HP	7282	W1	7649
Corner 78w 36d x 60w 24d	DZEK78366024	HP	7481	W1	7838
Corner 84w 30d x 60w 20d	DZEK84306020	HP	7332	W1	7698
Corner 84w 36d x 60w 24d	DZEK84366024	HP	7542	W1	7896
Corner 96w 30d x 60w 20d	DZEK96306020	HP	7434	W1	7793
Corner 96w 36d x 60w 24d	DZEK96366024	HP	7663	W1	8012

! Notes:

Standard HPL top material is Formica 949 White Matte.
 Standard Solid Surface material is Avonite Polaris White, Matte.
 OcuWrite Back-Painted Glass color: O.BWT White.
 Top finishes are listed above; specify Wood1 finish for elements below worksurface where applicable.
 Plinth bases are mitre folded construction. Available on 3 leg desk only.
 Plinth bases are priced in Wood1 options.

+ Options:

Specify leg color: White, Black or Silver.
 Specify L for left; or R for right hand runoff. Place at the end of product number.

Wall Hung Credenza 29.9-48.4h
 Height Adjustable
 Veneer Interior

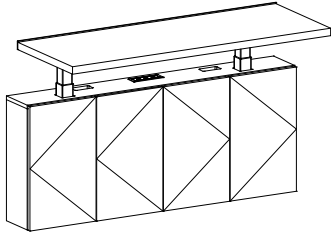

Description	Spec Code	List \$	Spec Code	List \$	Spec Code	List \$	Spec Code	List \$
	HPL Top		Wood1 Top		Solid Surface Top		OcuWrite Top	
Wall Hung 48w 24d	DZFA4824	HP 8477	W1 8878		SS 9646		AG 11000	
Wall Hung 48w 30d	DZFA4830	HP 9308	W1 9704		SS 10586		AG 12154	
Wall Hung 54w 24d	DZFA5424	HP 8844	W1 9244		SS 10083		AG 11568	
Wall Hung 54w 30d	DZFA5430	HP 9718	W1 10114		SS 11085		AG 12795	
• Wall Hung 60w 24d	DZFA6024	HP 9239	W1 9634		SS 10545		AG 12163	
Wall Hung 60w 30d	DZFA6030	HP 10157	W1 10547		SS 11608		AG 13465	
Wall Hung 66w 24d	DZFA6624	HP 9593	W1 9989		SS 10969		AG 12717	
Wall Hung 66w 30d	DZFA6630	HP 10554	W1 10943		SS 12090		AG 14092	
Wall Hung 72w 24d	DZFA7224	HP 9960	W1 10352		SS 11404		AG 13284	
Wall Hung 72w 30d	DZFA7230	HP 10963	W1 11349		SS 12586		AG 14733	
Wall Hung 78w 24d	DZFA7824	HP 10316	W1 10706		SS 11827		AG 13839	
Wall Hung 78w 30d	DZFA7830	HP 11361	W1 11744		SS 13069		AG 15362	

! Notes:

- Glass tops have metal edges; MRBAS, Metal Resin Brushed Aluminum w/ Steel Tint; HPL tops have PVC edges; all other tops are self-edged.
- Standard HPL top material is Formica 949 White Matte.
- Standard Solid Surface material is Avonite Polaris White, Matte.
- OcuWrite Back-Painted Glass color: O.BWT White.
- 24d units have a 9d base section.
- 30d units have a 15d base section.
- Vertical hinge door access standard on all units.
- All units must be attached to wall.
- Accessory power standard with Duplex and USB-A+C, soft plug.
- Tops are included with wall hung units.
- No locks.
- Pencil catches are standard on Wall Hung Credenzas.
- Pencil catch finish standard as MRBAS, Brushed Aluminum w/Steel Tint.

+ Options:

- Specify White, Silver or Black for height adjustable leg color.
- To add metal edge to Wood, Laminate or Acrylic Solid Surface tops, add ME to the end of Spec code, and price that correlates to top size from metal edge table.

Wall Hung Credenza 29.9-48.4h
 Height Adjustable
 Cabinet Grade Interior

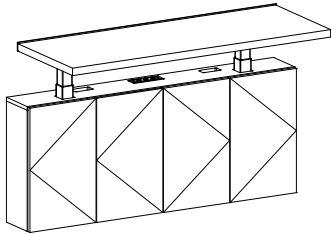

Description	Spec Code	List \$	Spec Code	List \$	Spec Code	List \$	Spec Code	List \$	
	HPL Top		Wood1 Top		Solid Surface Top		OcuWrite Top		
Wall Hung 48w 24d	DZfZ4824	HP	5311	W1	5583	SS	6599	AG	7677
Wall Hung 48w 30d	DZfZ4830	HP	5715	W1	5989	SS	7060	AG	8406
Wall Hung 54w 24d	DZfZ5424	HP	5541	W1	5813	SS	6859	AG	8070
Wall Hung 54w 30d	DZfZ5430	HP	5957	W1	6232	SS	7362	AG	8877
• Wall Hung 60w 24d	DZfZ6024	HP	5742	W1	6014	SS	7114	AG	8460
Wall Hung 60w 30d	DZfZ6030	HP	6180	W1	6450	SS	7635	AG	9318
Wall Hung 66w 24d	DZfZ6624	HP	6160	W1	6215	SS	7364	AG	8844
Wall Hung 66w 30d	DZfZ6630	HP	6706	W1	6692	SS	7932	AG	9783
Wall Hung 72w 24d	DZfZ7224	HP	6160	W1	6426	SS	7623	AG	9238
Wall Hung 72w 30d	DZfZ7230	HP	6706	W1	6929	SS	8233	AG	10252
Wall Hung 78w 24d	DZfZ7824	HP	6413	W1	6632	SS	7887	AG	9637
Wall Hung 78w 30d	DZfZ7830	HP	6944	W1	7162	SS	8525	AG	10713

! Notes:

Glass tops have metal edges; MRBAS, Metal Resin Brushed Aluminum w/ Steel Tint; HPL tops have PVC edges; all other tops are self-edged.
 Standard HPL top material is Formica 949 White Matte.
 Standard Solid Surface material is Avonite Polaris White, Matte.
 OcuWrite Back-Painted Glass color: O.BWT White.
 24d units have a 9d base section.
 30d units have a 15d base section.
 Vertical hinge door access standard on all units.
 All units must be attached to wall.
 Tops are included with wall hung units.
 No locks.
 Pencil catches are standard on Wall Hung Credenzas.
 Pencil catch finish standard as MRBAS, Brushed Aluminum w/Steel Tint.

+ Options:

Specify White, Silver or Black for height adjustable leg color.
 To add metal edge to Wood, Laminate or Acrylic Solid Surface tops, add ME to the end of Spec code, and price that correlates to top size from metal edge table.
 To add Power, add "PWR" to end of Item Number; Add \$278. Power includes, Duplex and USB-A+C, soft plug.

Pedestals 22.4h

Description	Prod.No.	List \$	Prod.No.	List \$				
	20d		24d					
Low Pedestals	DZFB	\$ sum	DZFC	\$ sum				
Low Pedestals w/ Toe Kick	DZFBTK	\$ sum	DZFKTK	\$ sum				
	Spec Code		Spec Code		Spec Code	Add \$	Spec Code	Add \$
	Wood1 Faces		Wood1 Faces		Acrylic Faces		Finished Back	
Shelving 16w	A16	1399	A16	1456	—	—	FB	+75
• Shelving 18w	A18	1441	A18	1497	—	—	FB	+83
Shelving 20w	A20	1482	A20	1538	—	—	FB	+92
Shelving 24w	A24	1567	A24	1623	—	—	FB	+111
Shelving 30w	A30	1692	A30	1750	—	—	FB	+140
Shelving 36w	A36	1817	A36	1874	—	—	FB	+166
Cabinet 16w LH	CL16	1910	CL16	1969	A	+437	FB	+75
Cabinet 16w RH	CR16	1910	CR16	1969	A	+437	FB	+75
• Cabinet 18w LH	CL18	1967	CL18	2025	A	+437	FB	+83
Cabinet 18w RH	CR18	1967	CR18	2025	A	+437	FB	+83
Cabinet 20w LH	CL20	2023	CL20	2081	A	+437	FB	+92
Cabinet 20w RH	CR20	2023	CR20	2081	A	+437	FB	+92
Cabinet 24w DBL	C24	2177	C24	2234	A	+437	FB	+111
Cabinet 30w DBL	C30	2323	C30	2401	A	+437	FB	+140
Cabinet 36w DBL	C36	2513	C36	2570	A	+437	FB	+166
Box/File 16w	R16	2112	R16	2212	A	+437	FB	+75
• Box/File 18w	R18	2134	R18	2218	A	+437	FB	+83
Box/File 20w	R20	2180	R20	2280	A	+437	FB	+92
Box/File 24w	R24	2230	R24	2335	A	+437	FB	+111
Box/File 30w	R30	2349	R30	2455	A	+437	FB	+140
Box/File 36w	R36	2451	R36	2559	A	+437	FB	+166
Open/File 16w	W16	2046	W16	2201	A	+437	FB	+75
• Open/File 18w	W18	2076	W18	2221	A	+437	FB	+83
Open/File 20w	W20	2117	W20	2283	A	+437	FB	+92
Open/File 24w	W24	2182	W24	2359	A	+437	FB	+111
Open/File 30w	W30	2305	W30	2501	A	+437	FB	+140
Open/File 36w	W36	2411	W36	2621	A	+437	FB	+166
Trash/Recycle 18w	T18	2035	T18	2159	A	+437	FB	+83
Trash/Recycle 20w	T20	2105	T20	2192	A	+437	FB	+92
Trash/Recycle 24w	T24	2170	T24	2283	A	+437	FB	+111

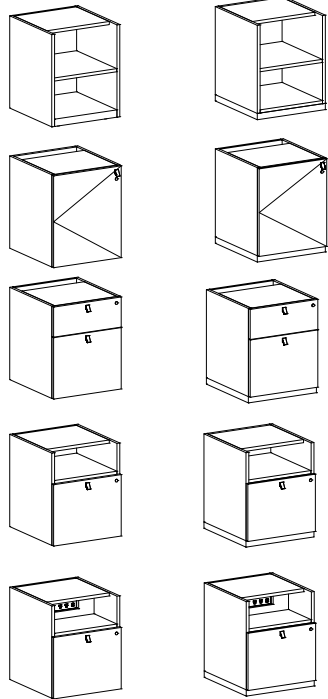

! Notes:

All pedestals have unfinished backs and are manufactured as combined units.
 X4 extends the outer end panels 4 inches, to 24d, inside panels remain at 20d. Only available on 20d pedestals.
 Pull finish is standard MRBAS, for polished specify MPA, Polished Aluminum.
 Toe kick finish is standard MRBAS, Brushed Aluminum w/Steel Tint; for polished specify MPA, Polished Aluminum.
 Locks included standard.
 Power option on Open/File, includes (1) 60w USB-C, (2) Simplex and (2) Standard USB charging.
 Acrylic faces are Stylelite Arctic White standard.
 Trash/Recycle units 18w x 20d and 20w x 20d contain (1) Trash/Recycle bin.
 Trash/Recycle units 24w x 20d and all units 24d contain (2) Trash/Recycle bins.

+ Options:

For pedestals with toe kick, use prefix code with toe kick.
 To extend the 20d pedestals on the end for wire passage, append X4 to end of the prefix code; Add \$159.
 To add power to the Open/File pedestal, append PWR to the spec code; add \$1135.
 To change faces to Acrylic, add A to the spec code and add dollar amount for faces to total.
 To add finished back add FB and add dollar amount to total.
 For ventilation cutout add code VS, add \$459 to pedestal.

Pedestals 28.4h

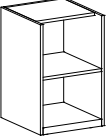
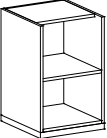
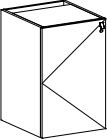
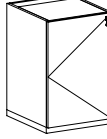
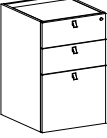
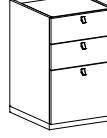
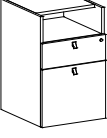
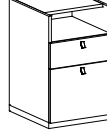
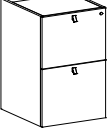
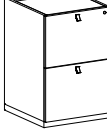
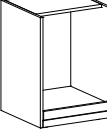
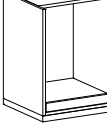
Description	Prod.No.	List \$	Prod.No.	List \$	Prod.No.	List \$	Prod.No.	List \$	Spec Code	Add \$	Spec Code	Add \$		
	20d		24d		30d		36d		Wood1 Faces		Acrylic Faces	Finished Back		
Pedestals	DZFD	\$ sum	DZFE	\$ sum	DZFF	\$ sum	DZFG	\$ sum						
Pedestals w/ Toe Kick	DZFDTK	\$ sum	DZFETK	\$ sum	DZFFTK	\$ sum	DZFGTK	\$ sum						
		Shelving 16w	A16	1489	A16	1560	—	—	—	—	—	FB	+92	
		• Shelving 18w	A18	1532	A18	1605	—	—	—	—	—	FB	+105	
		Shelving 20w	A20	1577	A20	1649	—	—	—	—	—	FB	+114	
		Shelving 24w	A24	1666	A24	1737	—	—	—	—	—	FB	+140	
		Shelving 30w	A30	1798	A30	1870	—	—	—	—	—	FB	+172	
		Shelving 36w	A36	1932	A36	2004	—	—	—	—	—	FB	+207	
		Cabinet 16w LH	CL16	2000	CL16	2074	—	—	—	A	+437	FB	+92	
		Cabinet 16w RH	CR16	2000	CR16	2074	—	—	—	A	+437	FB	+92	
		• Cabinet 18w LH	CL18	2059	CL18	2132	—	—	—	A	+437	FB	+105	
		Cabinet 18w RH	CR18	2059	CR18	2132	—	—	—	A	+437	FB	+105	
		Cabinet 20w LH	CL20	2120	CL20	2191	—	—	—	A	+437	FB	+114	
		Cabinet 20w RH	CR20	2120	CR20	2191	—	—	—	A	+437	FB	+114	
		Cabinet 24w LH	CL24	2235	CL24	2307	—	—	—	A	+437	FB	+140	
		Cabinet 24w RH	CR24	2235	CR24	2307	—	—	—	A	+437	FB	+140	
		Cabinet 30w DBL	C30	2429	C30	2524	—	—	—	A	+437	FB	+172	
		Cabinet 36w DBL	C36	2628	C36	2701	—	—	—	A	+437	FB	+207	
		2Box/File 16w	H16	2429	H16	2543	H16	2874	H16	2967	A	+437	FB	+92
		• 2Box/File 18w	H18	2451	H18	2554	H18	2931	H18	3026	A	+437	FB	+105
		2Box/File 20w	H20	2513	H20	2630	H20	2966	H20	3067	A	+437	FB	+114
		2Box/File 24w	H24	2577	H24	2703	—	—	—	A	+437	FB	+140	
		2Box/File 30w	H30	2729	H30	2854	—	—	—	A	+437	FB	+172	
		2Box/File 36w	H36	2861	H36	2990	—	—	—	A	+437	FB	+207	
		Open/Box/File 16w	X16	2372	X16	2547	X16	2818	X16	2949	A	+437	FB	+92
		• Open/Box/File 18w	X18	2403	X18	2569	X18	2878	X18	3015	A	+437	FB	+105
		Open/Box/File 20w	X20	2460	X20	2649	X20	2922	X20	3062	A	+437	FB	+114
		Open/Box/File 24w	X24	2538	X24	2742	—	—	—	A	+437	FB	+140	
		Open/Box/File 30w	X30	2693	X30	2914	—	—	—	A	+437	FB	+172	
		Open/Box/File 36w	X36	2832	X36	3068	—	—	—	A	+437	FB	+207	
		File/File 16w	K16	2247	K16	2405	K16	2599	K16	2693	A	+437	FB	+92
		• File/File 18w	K18	2275	K18	2400	K18	2653	K18	2749	A	+437	FB	+105
		File/File 20w	K20	2327	K20	2484	K20	2686	K20	2788	A	+437	FB	+114
		File/File 24w	K24	2395	K24	2558	—	—	—	A	+437	FB	+140	
		File/File 30w	K30	2552	K30	2715	—	—	—	A	+437	FB	+172	
		File/File 36w	K36	2671	K36	2837	—	—	—	A	+437	FB	+207	
		Utility Tray 16w	U16	2046	U16	2124	—	—	—	—	—	FB	+92	
		• Utility Tray 18w	U18	2070	U18	2151	—	—	—	—	—	FB	+105	
		Utility Tray 20w	U20	2109	U20	2189	—	—	—	—	—	FB	+114	
		Utility Tray 24w	U24	2164	U24	2247	—	—	—	—	—	FB	+140	
		Utility Tray 30w	U30	2264	U30	2345	—	—	—	—	—	FB	+172	
		Utility Tray 36w	U36	2360	U36	2443	—	—	—	—	—	FB	+207	
		Trash/Recycle 18w	T18	2191	T18	2316	—	—	—	A	+437	FB	+105	
		Trash/Recycle 20w	T20	2222	T20	2347	—	—	—	A	+437	FB	+114	
		Trash/Recycle 24w	T24	2309	T24	2434	—	—	—	A	+437	FB	+140	

> See following page for Notes and Options.

Pedestals 28.4h (cont.)

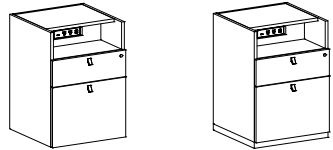

Description	Product No.	Spec Code	List \$	Spec Code	Add \$
<p>! Notes (for product listing on prior page): All pedestals have unfinished backs and are manufactured as combined units. X4 extends the outer end panels 4 inches, to 24d, inside panels remain at 20d. Only available on 20d pedestals. X6 extends the outer end panels 6 inches, to 30 in, 36in. Inside panels remain at 24 and 30 inches. Only available on 24d and 30d pedestals. Pull finish is standard MRBAS, Brushed Aluminum w/Steel tint; for polished specify MPA, Polished Aluminum. Toe kick finish is standard MRBAS, Brushed Aluminum w/Steel Tint; for polished specify MPA, Polished Aluminum. Acrylic faces are Stylelite Arctic White standard. Locks included standard. Power option on Open/Box/File, includes (1) 60w USB-C, (2) Simplex and (2) Standard USB charging. Trash/Recycle units 18w x 20d and 20w x 20d contain (1) Trash/Recycle bin. Trash/Recycle units 24w x 20d and all units 24d contain (2) Trash/Recycle bins.</p> <p>+ Options: For pedestals with toe kick, use prefix code with toe kick. To extend the 20d pedestals on the end for wire passage, append X4 to end of the prefix code; add \$193. To extend the 30d pedestals on the end for wire passage, append X6 to end of the prefix code; add \$290. To add power to the Open/Box/File pedestal, append PWR to the spec code; add \$1135. To change faces to Acrylic, add A to the spec code and add dollar amount for faces to total. To add finished back add FB and add dollar amount to total. For ventilation cutout add code VS, add \$459 to pedestal.</p>					

Mobile Pedestals 21h

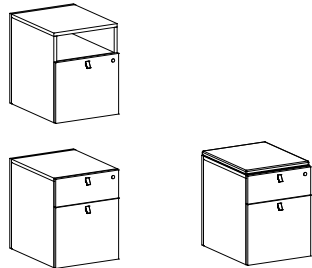

20d		Open/File		Box/File		Acrylic Faces	
Mobile Ped 16w		DZFHF16	2046	DZFHBF16	2112	A	+437
Mobile Ped 18w		DZFHF18	2076	DZFHBF18	2134	A	+437
Mobile Ped 24w		DZFHF24	2117	DZFHBF24	2180	A	+437
20d	COM yds	Open/File		Box/File		Acrylic Faces	
• Mobile Ped 16w w Cushion	1	DZFHF16C	2313	DZFHBF16C	2381	A	+437
Mobile Ped 18w w Cushion	1	DZFHF18C	2343	DZFHBF18C	2399	A	+437
Mobile Ped 24w w Cushion	1	DZFHF24C	2384	DZFHBF24C	2447	A	+437

! Notes:
 Pull finish is standard MRBAS, Brushed Aluminum w/Steel tint; for polished specify MPA, Polished Aluminum.
 Locks included standard.
 Finished backs standard.

+ Options:
 Acrylic faces are Stylelite Arctic White standard.

Modesty Panels

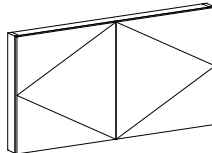
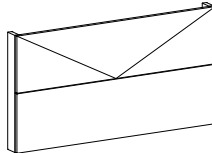
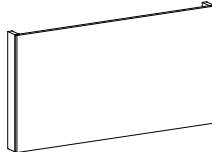
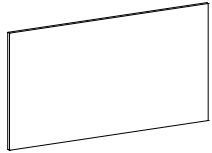

Description	Product No.	List \$	Product No.	List \$	Product No.	List \$	Product No.	List \$
22.4h	Fixed Finished Back 0.75d		Removable 3d		Horizontal Hinged 3d		Vertical Hinged 3d	
ModPanel: Low Credenza 16w	DZGFA-16	546	DZGRA-16	627	—	—	—	—
ModPanel: Low Credenza 18w	DZGFA-18	561	DZGRA-18	641	—	—	—	—
ModPanel: Low Credenza 20w	DZGFA-20	574	DZGRA-20	656	—	—	—	—
ModPanel: Low Credenza 24w	DZGFA-24	604	DZGRA-24	685	—	—	—	—
ModPanel: Low Credenza 30w	DZGFA-30	645	DZGRA-30	728	—	—	—	—
ModPanel: Low Credenza 36w	DZGFA-36	690	DZGRA-36	771	DZGHA-36	1148	DZGVA-36	1242
ModPanel: Low Credenza 42w	DZGFA-42	732	DZGRA-42	814	DZGHA-42	1190	DZGVA-42	1286
ModPanel: Low Credenza 48w	DZGFA-48	775	DZGRA-48	857	DZGHA-48	1234	DZGVA-48	1329
ModPanel: Low Credenza 54w	DZGFA-54	818	DZGRA-54	899	DZGHA-54	1277	DZGVA-54	1372
ModPanel: Low Credenza 60w	DZGFA-60	862	DZGRA-60	1118	DZGHA-60	1553	DZGVA-60	1637
ModPanel: Low Credenza 72w	DZGFA-72	904	DZGRA-72	1160	DZGHA-72	1595	DZGVA-72	1680
ModPanel: Low Credenza 84w	—	—	DZGRA-84	1205	DZGHA-84	1639	DZGVA-84	1724
ModPanel: Low Credenza 96w	—	—	DZGRA-96	1247	DZGHA-96	1681	DZGVA-96	1767
ModPanel: Low Credenza 108w	—	—	DZGRA-108	1293	DZGHA-108	1725	DZGVA-108	1810
ModPanel: Low Credenza 120w	—	—	DZGRA-120	1335	DZGHA-120	1768	DZGVA-120	1852
28.4	Fixed Finished Back 0.75d		Removable 3d		Horizontal Hinged 3d		Vertical Hinged 3d	
ModPanel: Credenza 16w	DZGFB-16	574	DZGRB-16	656	—	—	—	—
ModPanel: Credenza 18w	DZGFB-18	592	DZGRB-18	673	—	—	—	—
ModPanel: Credenza 20w	DZGFB-20	610	DZGRB-20	692	—	—	—	—
ModPanel: Credenza 24w	DZGFB-24	645	DZGRB-24	728	—	—	—	—
ModPanel: Credenza 30w	DZGFB-30	699	DZGRB-30	781	—	—	—	—
ModPanel: Credenza 36w	DZGFB-36	753	DZGRB-36	835	DZGHB-36	1212	DZGVB-36	1306
ModPanel: Credenza 42w	DZGFB-42	809	DZGRB-42	890	DZGHB-42	1266	DZGVB-42	1360
ModPanel: Credenza 48w	DZGFB-48	862	DZGRB-48	944	DZGHB-48	1320	DZGVB-48	1414
ModPanel: Credenza 54w	DZGFB-54	917	DZGRB-54	999	DZGHB-54	1373	DZGVB-54	1468
ModPanel: Credenza 60w	DZGFB-60	970	DZGRB-60	1264	DZGHB-60	1698	DZGVB-60	1783
ModPanel: Credenza 72w	DZGFB-72	1024	DZGRB-72	1318	DZGHB-72	1751	DZGVB-72	1836
ModPanel: Credenza 84w	—	—	DZGRB-84	1372	DZGHB-84	1807	DZGVB-84	1890
ModPanel: Credenza 96w	—	—	DZGRB-96	1425	DZGHB-96	1861	DZGVB-96	1944
ModPanel: Credenza 108w	—	—	DZGRB-108	1478	DZGHB-108	1914	DZGVB-108	1997
ModPanel: Credenza 120w	—	—	DZGRB-120	1533	DZGHB-120	1967	DZGVB-120	2052

! Notes:

Panels over 54 inches come with T panel included.

Parametric pricing, use price of panel just larger than size needed, Replace dimension on Product number with actual dimension.

+ Options (for all except Fixed Finished Back panels):

For finished end left, add L to the product number.

Ex. For 16w 22.4h Removable ModPanel with finished end left, product number is DZGRA-16L

For finished end right, add R to the product number.

For finished both ends, add B to the product number.

Base Panels

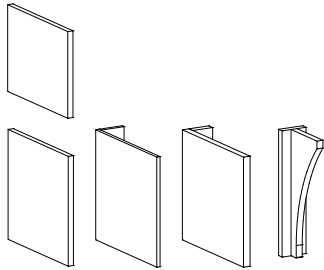

Description	Product No.	List \$	Product No.	List \$	Product No.	List \$	Product No.	List \$
22.4h	End Panels 1.5th		L-Panels 6w 0.75th		L-Panels 6w 1.5th		T-Panels 6w 1.5th	
Base Panel 20d 22.4h	DZHA20	628	DZHC20	618	DZHE20	678	DZHG20	731
Base Panel 24d 22.4h	DZHA24	678	DZHC24	645	DZHE24	727	DZHG24	780
• Base Panel 30d 22.4h	DZHA30	727	DZHC30	690	DZHE30	776	DZHG30	830
Base Panel 36d 22.4h	DZHA36	776	DZHC36	732	DZHE36	826	DZHG36	880
28.4h	End Panels 1.5th		L-Panels 6w 0.75th		L-Panels 6w 1.5th		T-Panels 6w 1.5th	
Base Panel 20d 28.4h	DZHB20	678	DZHD20	664	DZHF20	739	DZHH20	793
Base Panel 24d 28.4h	DZHB24	739	DZHD24	699	DZHF24	802	DZHH24	856
• Base Panel 30d 28.4h	DZHB30	802	DZHD30	753	DZHF30	863	DZHH30	917
Base Panel 36d 28.4h	DZHB36	863	DZHD36	809	DZHF36	923	DZHH36	977

! Notes:

End Panels to be used only next to pedestals.
 L-Panels to be used when not next to a pedestal.
 Specify L for left, or R for right hand End or L-panel. Place at the end of the Product number.
 T-Panels must be used on open spans larger than 54w.

Top Supports



1.5th			
Top Supports 12w 4.5h	DZHJ12	537	
• Top Supports 15w 4.5h	DZHJ15	548	
Top Supports 18w 4.5h	DZHJ18	561	

! Notes:

Top supports assist in the transition of tops from standard height to low credenza height.

Tops, High Pressure Laminate

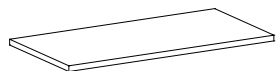

Description	Product No.	List \$	Product No.	List \$	Product No.	List \$	Product No.	List \$	Product No.	List \$	Product No.	List \$		
PVC Edge 1.5th	20d		24d		30d		36d		42d		48d		60d	
Top/Flat HPL:Self 16w	DZJA2016	743	DZJA2416	761	DZJA3016	786	DZJA3616	814	DZJA4216	841	DZJA4816	867	DZJA6016	922
Top/Flat HPL:Self 18w	DZJA2018	753	DZJA2418	774	DZJA3018	804	DZJA3618	835	DZJA4218	864	DZJA4818	895	DZJA6018	956
Top/Flat HPL:Self 20w	DZJA2020	767	DZJA2420	786	DZJA3020	822	DZJA3620	856	DZJA4220	888	DZJA4820	922	DZJA6020	989
Top/Flat HPL:Self 24w	DZJA2024	786	DZJA2424	814	DZJA3024	856	DZJA3624	895	DZJA4224	935	DZJA4824	975	DZJA6024	1057
Top/Flat HPL:Self 30w	DZJA2030	822	DZJA2430	856	DZJA3030	904	DZJA3630	956	DZJA4230	1006	DZJA4830	1057	DZJA6030	1158
Top/Flat HPL:Self 36w	DZJA2036	856	DZJA2436	895	DZJA3036	956	DZJA3636	1016	DZJA4236	1076	DZJA4836	1139	DZJA6036	1260
Top/Flat HPL:Self 42w	DZJA2042	888	DZJA2442	935	DZJA3042	1006	DZJA3642	1076	DZJA4242	1149	DZJA4842	1219	DZJA6042	1360
Top/Flat HPL:Self 48w	DZJA2048	922	DZJA2448	975	DZJA3048	1057	DZJA3648	1139	DZJA4248	1219	DZJA4848	1300	DZJA6048	1462
Top/Flat HPL:Self 54w	DZJA2054	956	DZJA2454	1016	DZJA3054	1106	DZJA3654	1200	DZJA4254	1290	DZJA4854	1380	DZJA6054	1561
• Top/Flat HPL:Self 60w	DZJA2060	989	DZJA2460	1057	DZJA3060	1158	DZJA3660	1260	DZJA4260	1360	DZJA4860	1462	DZJA6060	1663
Top/Flat HPL:Self 66w	DZJA2066	1024	DZJA2466	1097	DZJA3066	1210	DZJA3666	1320	DZJA4266	1431	DZJA4866	1542	DZJA6066	1765
Top/Flat HPL:Self 72w	DZJA2072	1057	DZJA2472	1139	DZJA3072	1260	DZJA3672	1380	DZJA4272	1502	DZJA4872	1623	DZJA6072	1867
Top/Flat HPL:Self 78w	DZJA2078	1092	DZJA2478	1178	DZJA3078	1310	DZJA3678	1442	DZJA4278	1573	DZJA4878	1704	DZJA6078	1967
Top/Flat HPL:Self 84w	DZJA2084	1124	DZJA2484	1219	DZJA3084	1360	DZJA3684	1502	DZJA4284	1643	DZJA4884	1786	DZJA6084	2069
Top/Flat HPL:Self 90w	DZJA2090	1158	DZJA2490	1260	DZJA3090	1411	DZJA3690	1561	DZJA4290	1716	DZJA4890	1867	DZJA6090	2169
Top/Flat HPL:Self 96w	DZJA2096	1192	DZJA2496	1300	DZJA3096	1462	DZJA3696	1623	DZJA4296	1786	DZJA4896	1947	DZJA6096	2271
Top/Flat HPL:Self 102w	DZJA2102	1225	DZJA24102	1341	DZJA30102	1512	DZJA36102	1684	DZJA42102	1855	DZJA48102	2028	DZJA60102	2372
Top/Flat HPL:Self 108w	DZJA2108	1260	DZJA24108	1380	DZJA30108	1561	DZJA36108	1745	DZJA42108	1927	DZJA48108	2108	DZJA60108	2473
Top/Flat HPL:Self 114w	DZJA2114	1294	DZJA24114	1421	DZJA30114	1613	DZJA36114	1807	DZJA42114	1997	DZJA48114	2189	DZJA60114	2574
Top/Flat HPL:Self 120w	DZJA20120	1328	DZJA24120	1462	DZJA30120	1663	DZJA36120	1867	DZJA42120	2069	DZJA48120	2271	DZJA60120	2675

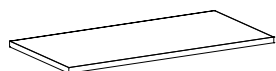

Description	Suffix Code.	Add \$	Suffix Code	Add \$	Suffix Code	Add \$	Suffix Code.	Add \$	Suffix Code	Add \$	Suffix Code	Add \$	Suffix Code	Add \$
Metal Edge 1.5th	20d		24d		30d		36d		42d		48d		60d	
Top/Flat HPL:Metal 16w	...ME	1074	...ME	1127	...ME	1204	...ME	1281	...ME	1358	...ME	1435	...ME	1590
Top/Flat HPL:Metal 18w	...ME	1099	...ME	1152	...ME	1230	...ME	1305	...ME	1384	...ME	1462	...ME	1615
Top/Flat HPL:Metal 20w	...ME	1127	...ME	1177	...ME	1257	...ME	1331	...ME	1409	...ME	1488	...ME	1642
Top/Flat HPL:Metal 24w	...ME	1177	...ME	1230	...ME	1305	...ME	1384	...ME	1462	...ME	1538	...ME	1695
Top/Flat HPL:Metal 30w	...ME	1257	...ME	1305	...ME	1384	...ME	1462	...ME	1538	...ME	1615	...ME	1771
Top/Flat HPL:Metal 36w	...ME	1331	...ME	1384	...ME	1462	...ME	1538	...ME	1615	...ME	1695	...ME	1848
Top/Flat HPL:Metal 42w	...ME	1409	...ME	1462	...ME	1538	...ME	1615	...ME	1695	...ME	1771	...ME	1926
Top/Flat HPL:Metal 48w	...ME	1488	...ME	1538	...ME	1615	...ME	1695	...ME	1771	...ME	1848	...ME	2004
Top/Flat HPL:Metal 54w	...ME	1562	...ME	1615	...ME	1695	...ME	1771	...ME	1848	...ME	1926	...ME	2080
Top/Flat HPL:Metal 60w	...ME	1642	...ME	1695	...ME	1771	...ME	1848	...ME	1926	...ME	2004	...ME	2158
Top/Flat HPL:Metal 66w	...ME	1720	...ME	1771	...ME	1848	...ME	1926	...ME	2004	...ME	2080	...ME	2235
Top/Flat HPL:Metal 72w	...ME	1797	...ME	1848	...ME	1926	...ME	2004	...ME	2080	...ME	2158	...ME	2312
Top/Flat HPL:Metal 78w	...ME	1873	...ME	1926	...ME	2004	...ME	2080	...ME	2158	...ME	2235	...ME	2390
Top/Flat HPL:Metal 84w	...ME	1952	...ME	2004	...ME	2080	...ME	2158	...ME	2235	...ME	2312	...ME	2469
Top/Flat HPL:Metal 90w	...ME	2029	...ME	2080	...ME	2158	...ME	2235	...ME	2312	...ME	2390	...ME	2544
Top/Flat HPL:Metal 96w	...ME	2105	...ME	2158	...ME	2235	...ME	2312	...ME	2390	...ME	2469	...ME	2621
Top/Flat HPL:Metal 102w	...ME	2183	...ME	2235	...ME	2312	...ME	2390	...ME	2469	...ME	2544	...ME	2701
Top/Flat HPL:Metal 108w	...ME	2262	...ME	2312	...ME	2390	...ME	2469	...ME	2544	...ME	2621	...ME	2777
Top/Flat HPL:Metal 114w	...ME	2337	...ME	2390	...ME	2469	...ME	2544	...ME	2621	...ME	2701	...ME	2854
Top/Flat HPL:Metal 120w	...ME	2416	...ME	2469	...ME	2544	...ME	2621	...ME	2701	...ME	2777	...ME	2932

! Notes:
 Standard HPL top material is Formica 949 White Matte.
 For metal edges, append ME to the Product No. and add the price shown above.
 > See page AD27 for additional Notes and Options.

Tops, Wood 1

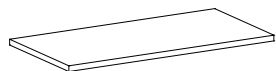

Description	Product No.	List \$	Product No.	List \$	Product No.	List \$	Product No.	List \$	Product No.	List \$	Product No.	List \$	Product No.	List \$
Self Edge, 1.5th	20d		24d		30d		36d		42d		48d		60d	
Top/Flat Wood1:Self 16w	DZJB2016	1154	DZJB2416	1172	DZJB3016	1196	DZJB3616	1222	DZJB4216	1247	DZJB4816	1275	DZJB6016	1324
Top/Flat Wood1:Self 18w	DZJB2018	1164	DZJB2418	1184	DZJB3018	1213	DZJB3618	1242	DZJB4218	1271	DZJB4818	1300	DZJB6018	1358
Top/Flat Wood1:Self 20w	DZJB2020	1176	DZJB2420	1196	DZJB3020	1230	DZJB3620	1261	DZJB4220	1294	DZJB4820	1324	DZJB6020	1389
Top/Flat Wood1:Self 24w	DZJB2024	1196	DZJB2424	1222	DZJB3024	1261	DZJB3624	1300	DZJB4224	1337	DZJB4824	1377	DZJB6024	1452
Top/Flat Wood1:Self 30w	DZJB2030	1230	DZJB2430	1261	DZJB3030	1307	DZJB3630	1358	DZJB4230	1406	DZJB4830	1452	DZJB6030	1550
Top/Flat Wood1:Self 36w	DZJB2036	1261	DZJB2436	1300	DZJB3036	1358	DZJB3636	1414	DZJB4236	1472	DZJB4836	1531	DZJB6036	1645
Top/Flat Wood1:Self 42w	DZJB2042	1294	DZJB2442	1337	DZJB3042	1406	DZJB3642	1472	DZJB4242	1539	DZJB4842	1608	DZJB6042	1742
Top/Flat Wood1:Self 48w	DZJB2048	1324	DZJB2448	1377	DZJB3048	1452	DZJB3648	1531	DZJB4248	1608	DZJB4848	1684	DZJB6048	1838
Top/Flat Wood1:Self 54w	DZJB2054	1358	DZJB2454	1414	DZJB3054	1502	DZJB3654	1589	DZJB4254	1675	DZJB4854	1761	DZJB6054	1934
Top/Flat Wood1:Self 60w	DZJB2060	1389	DZJB2460	1452	DZJB3060	1550	DZJB3660	1645	DZJB4260	1742	DZJB4860	1838	DZJB6060	2030
Top/Flat Wood1:Self 66w	DZJB2066	1421	DZJB2466	1493	DZJB3066	1597	DZJB3666	1703	DZJB4266	1809	DZJB4866	1915	DZJB6066	2127
Top/Flat Wood1:Self 72w	DZJB2072	1452	DZJB2472	1531	DZJB3072	1645	DZJB3672	1761	DZJB4272	1877	DZJB4872	1992	DZJB6072	2224
Top/Flat Wood1:Self 78w	DZJB2078	1486	DZJB2478	1569	DZJB3078	1695	DZJB3678	1819	DZJB4278	1944	DZJB4878	2070	DZJB6078	2318
Top/Flat Wood1:Self 84w	DZJB2084	1518	DZJB2484	1608	DZJB3084	1742	DZJB3684	1877	DZJB4284	2012	DZJB4884	2145	DZJB6084	2416
Top/Flat Wood1:Self 90w	DZJB2090	1550	DZJB2490	1645	DZJB3090	1790	DZJB3690	1934	DZJB4290	2079	DZJB4890	2224	DZJB6090	2512
Top/Flat Wood1:Self 96w	DZJB2096	1580	DZJB2496	1684	DZJB3096	1838	DZJB3696	1992	DZJB4296	2145	DZJB4896	2301	DZJB6096	2610
Top/Flat Wood1:Self 102w	DZJB2102	1614	DZJB24102	1722	DZJB30102	1886	DZJB36102	2050	DZJB42102	2214	DZJB48102	2376	DZJB60102	2704
Top/Flat Wood1:Self 108w	DZJB2108	1645	DZJB24108	1761	DZJB30108	1934	DZJB36108	2106	DZJB42108	2282	DZJB48108	2454	DZJB60108	2800
Top/Flat Wood1:Self 114w	DZJB2114	1678	DZJB24114	1799	DZJB30114	1982	DZJB36114	2164	DZJB42114	2347	DZJB48114	2531	DZJB60114	2897
Top/Flat Wood1:Self 120w	DZJB2120	1708	DZJB24120	1838	DZJB30120	2030	DZJB36120	2224	DZJB42120	2416	DZJB48120	2610	DZJB60120	2995

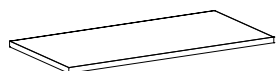

Description	Suffix Code.	Add \$	Suffix Code	Add \$	Suffix Code	Add \$	Suffix Code.	Add \$	Suffix Code	Add \$	Suffix Code	Add \$	Suffix Code	Add \$
Metal Edge 1.5th	20d		24d		30d		36d		42d		48d		60d	
Top/Flat Wood1:Metal 16w	...ME	1074	...ME	1127	...ME	1204	...ME	1281	...ME	1358	...ME	1435	...ME	1590
Top/Flat Wood1:Metal 18w	...ME	1099	...ME	1152	...ME	1230	...ME	1305	...ME	1384	...ME	1462	...ME	1615
Top/Flat Wood1:Metal 20w	...ME	1127	...ME	1177	...ME	1257	...ME	1331	...ME	1409	...ME	1488	...ME	1642
Top/Flat Wood1:Metal 24w	...ME	1177	...ME	1230	...ME	1305	...ME	1384	...ME	1462	...ME	1538	...ME	1695
Top/Flat Wood1:Metal 30w	...ME	1257	...ME	1305	...ME	1384	...ME	1462	...ME	1538	...ME	1615	...ME	1771
Top/Flat Wood1:Metal 36w	...ME	1331	...ME	1384	...ME	1462	...ME	1538	...ME	1615	...ME	1695	...ME	1848
Top/Flat Wood1:Metal 42w	...ME	1409	...ME	1462	...ME	1538	...ME	1615	...ME	1695	...ME	1771	...ME	1926
Top/Flat Wood1:Metal 48w	...ME	1488	...ME	1538	...ME	1615	...ME	1695	...ME	1771	...ME	1848	...ME	2004
Top/Flat Wood1:Metal 54w	...ME	1562	...ME	1615	...ME	1695	...ME	1771	...ME	1848	...ME	1926	...ME	2080
Top/Flat Wood1:Metal 60w	...ME	1642	...ME	1695	...ME	1771	...ME	1848	...ME	1926	...ME	2004	...ME	2158
Top/Flat Wood1:Metal 66w	...ME	1720	...ME	1771	...ME	1848	...ME	1926	...ME	2004	...ME	2080	...ME	2235
Top/Flat Wood1:Metal 72w	...ME	1797	...ME	1848	...ME	1926	...ME	2004	...ME	2080	...ME	2158	...ME	2312
Top/Flat Wood1:Metal 78w	...ME	1873	...ME	1926	...ME	2004	...ME	2080	...ME	2158	...ME	2235	...ME	2390
Top/Flat Wood1:Metal 84w	...ME	1952	...ME	2004	...ME	2080	...ME	2158	...ME	2235	...ME	2312	...ME	2469
Top/Flat Wood1:Metal 90w	...ME	2029	...ME	2080	...ME	2158	...ME	2235	...ME	2312	...ME	2390	...ME	2544
Top/Flat Wood1:Metal 96w	...ME	2105	...ME	2158	...ME	2235	...ME	2312	...ME	2390	...ME	2469	...ME	2621
Top/Flat Wood1:Metal 102w	...ME	2183	...ME	2235	...ME	2312	...ME	2390	...ME	2469	...ME	2544	...ME	2701
Top/Flat Wood1:Metal 108w	...ME	2262	...ME	2312	...ME	2390	...ME	2469	...ME	2544	...ME	2621	...ME	2777
Top/Flat Wood1:Metal 114w	...ME	2337	...ME	2390	...ME	2469	...ME	2544	...ME	2621	...ME	2701	...ME	2854
Top/Flat Wood1:Metal 120w	...ME	2416	...ME	2469	...ME	2544	...ME	2621	...ME	2701	...ME	2777	...ME	2932

! Notes:
 Standard HPL top material is Formica 949 White Matte.
 For metal edges, append ME to the Product No. and add the price shown above.
 > See page AD27 for additional Notes and Options.

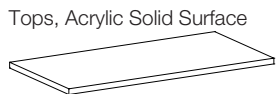

Description	Product No.	List \$	Product No.	List \$	Product No.	List \$	Product No.	List \$	Product No.	List \$	Product No.	List \$	Product No.	List \$
Self Edge, 1.5th	20d		24d		30d		36d		42d		48d		60d	
Top/Flat SolidS:Self 16w	DZJC2016	1621	DZJC2416	1671	DZJC3016	1742	DZJC3616	1815	DZJC4216	1890	DZJC4816	1961	DZJC6016	2106
Top/Flat SolidS:Self 18w	DZJC2018	1651	DZJC2418	1706	DZJC3018	1789	DZJC3618	1870	DZJC4218	1953	DZJC4818	2035	DZJC6018	2199
Top/Flat SolidS:Self 20w	DZJC2020	1681	DZJC2420	1742	DZJC3020	1834	DZJC3620	1926	DZJC4220	2016	DZJC4820	2106	DZJC6020	2289
Top/Flat SolidS:Self 24w	DZJC2024	1742	DZJC2424	1815	DZJC3024	1926	DZJC3624	2035	DZJC4224	2144	DZJC4824	2253	DZJC6024	2473
Top/Flat SolidS:Self 30w	DZJC2030	1834	DZJC2430	1926	DZJC3030	2063	DZJC3630	2199	DZJC4230	2336	DZJC4830	2473	DZJC6030	2745
Top/Flat SolidS:Self 36w	DZJC2036	1926	DZJC2436	2035	DZJC3036	2199	DZJC3636	2364	DZJC4236	2528	DZJC4836	2690	DZJC6036	3020
Top/Flat SolidS:Self 42w	DZJC2042	2016	DZJC2442	2144	DZJC3042	2336	DZJC3642	2528	DZJC4242	2718	DZJC4842	2910	DZJC6042	3293
Top/Flat SolidS:Self 48w	DZJC2048	2106	DZJC2448	2253	DZJC3048	2473	DZJC3648	2690	DZJC4248	2910	DZJC4848	3129	DZJC6048	3568
Top/Flat SolidS:Self 54w	DZJC2054	2199	DZJC2454	2364	DZJC3054	2610	DZJC3654	2855	DZJC4254	3103	DZJC4854	3347	DZJC6054	3841
Top/Flat SolidS:Self 60w	DZJC2060	2289	DZJC2460	2473	DZJC3060	2745	DZJC3660	3020	DZJC4260	3293	DZJC4860	3568	DZJC6060	4114
Top/Flat SolidS:Self 66w	DZJC2066	2381	DZJC2466	2583	DZJC3066	2883	DZJC3666	3183	DZJC4266	3484	DZJC4866	3785	DZJC6066	4387
Top/Flat SolidS:Self 72w	DZJC2072	2473	DZJC2472	2690	DZJC3072	3020	DZJC3672	3347	DZJC4272	3677	DZJC4872	4006	DZJC6072	4662
Top/Flat SolidS:Self 78w	DZJC2078	2564	DZJC2478	2800	DZJC3078	3157	DZJC3678	3512	DZJC4278	3867	DZJC4878	4224	DZJC6078	4935
Top/Flat SolidS:Self 84w	DZJC2084	2654	DZJC2484	2910	DZJC3084	3293	DZJC3684	3677	DZJC4284	4060	DZJC4884	4442	DZJC6084	5209
Top/Flat SolidS:Self 90w	DZJC2090	2745	DZJC2490	3020	DZJC3090	3429	DZJC3690	3841	DZJC4290	4249	DZJC4890	4662	DZJC6090	5483
Top/Flat SolidS:Self 96w	DZJC2096	2837	DZJC2496	3129	DZJC3096	3568	DZJC3696	4006	DZJC4296	4442	DZJC4896	4880	DZJC6096	5755
Top/Flat SolidS:Self 102w	DZJC2102	2930	DZJC24102	3238	DZJC30102	3704	DZJC36102	4169	DZJC42102	4634	DZJC48102	5100	DZJC60102	6028
Top/Flat SolidS:Self 108w	DZJC20108	3020	DZJC24108	3347	DZJC30108	3841	DZJC36108	4332	DZJC42108	4825	DZJC48108	5319	DZJC60108	6302
Top/Flat SolidS:Self 114w	DZJC20114	3110	DZJC24114	3458	DZJC30114	3977	DZJC36114	4497	DZJC42114	5017	DZJC48114	5538	DZJC60114	6575
Top/Flat SolidS:Self 120w	DZJC20120	3203	DZJC24120	3568	DZJC30120	4114	DZJC36120	4662	DZJC42120	5209	DZJC48120	5755	DZJC60120	6850

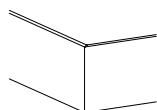

Description	Suffix Code.	Add \$	Suffix Code	Add \$	Suffix Code	Add \$	Suffix Code.	Add \$	Suffix Code	Add \$	Suffix Code	Add \$	Suffix Code	Add \$
Metal Edge 1.5th	20d		24d		30d		36d		42d		48d		60d	
Top/Flat SolidS:Metal 16w	...ME	1074	...ME	1127	...ME	1204	...ME	1281	...ME	1358	...ME	1435	...ME	1590
Top/Flat SolidS:Metal 18w	...ME	1099	...ME	1152	...ME	1230	...ME	1305	...ME	1384	...ME	1462	...ME	1615
Top/Flat SolidS:Metal 20w	...ME	1127	...ME	1177	...ME	1257	...ME	1331	...ME	1409	...ME	1488	...ME	1642
Top/Flat SolidS:Metal 24w	...ME	1177	...ME	1230	...ME	1305	...ME	1384	...ME	1462	...ME	1538	...ME	1695
Top/Flat SolidS:Metal 30w	...ME	1257	...ME	1305	...ME	1384	...ME	1462	...ME	1538	...ME	1615	...ME	1771
Top/Flat SolidS:Metal 36w	...ME	1331	...ME	1384	...ME	1462	...ME	1538	...ME	1615	...ME	1695	...ME	1848
Top/Flat SolidS:Metal 42w	...ME	1409	...ME	1462	...ME	1538	...ME	1615	...ME	1695	...ME	1771	...ME	1926
Top/Flat SolidS:Metal 48w	...ME	1488	...ME	1538	...ME	1615	...ME	1695	...ME	1771	...ME	1848	...ME	2004
Top/Flat SolidS:Metal 54w	...ME	1562	...ME	1615	...ME	1695	...ME	1771	...ME	1848	...ME	1926	...ME	2080
Top/Flat SolidS:Metal 60w	...ME	1642	...ME	1695	...ME	1771	...ME	1848	...ME	1926	...ME	2004	...ME	2158
Top/Flat SolidS:Metal 66w	...ME	1720	...ME	1771	...ME	1848	...ME	1926	...ME	2004	...ME	2080	...ME	2235
Top/Flat SolidS:Metal 72w	...ME	1797	...ME	1848	...ME	1926	...ME	2004	...ME	2080	...ME	2158	...ME	2312
Top/Flat SolidS:Metal 78w	...ME	1873	...ME	1926	...ME	2004	...ME	2080	...ME	2158	...ME	2235	...ME	2390
Top/Flat SolidS:Metal 84w	...ME	1952	...ME	2004	...ME	2080	...ME	2158	...ME	2235	...ME	2312	...ME	2469
Top/Flat SolidS:Metal 90w	...ME	2029	...ME	2080	...ME	2158	...ME	2235	...ME	2312	...ME	2390	...ME	2544
Top/Flat SolidS:Metal 96w	...ME	2105	...ME	2158	...ME	2235	...ME	2312	...ME	2390	...ME	2469	...ME	2621
Top/Flat SolidS:Metal 102w	...ME	2183	...ME	2235	...ME	2312	...ME	2390	...ME	2469	...ME	2544	...ME	2701
Top/Flat SolidS:Metal 108w	...ME	2262	...ME	2312	...ME	2390	...ME	2469	...ME	2544	...ME	2621	...ME	2777
Top/Flat SolidS:Metal 114w	...ME	2337	...ME	2390	...ME	2469	...ME	2544	...ME	2621	...ME	2701	...ME	2854
Top/Flat SolidS:Metal 120w	...ME	2416	...ME	2469	...ME	2544	...ME	2621	...ME	2701	...ME	2777	...ME	2932

! Notes:
 Standard Solid Surface material is Avonite Polaris White, Matte.
 For metal edges, append ME to the Product No. and add the price shown above.
 > See page AD27 for additional Notes and Options.

Tops, OcuWrite BPGlass

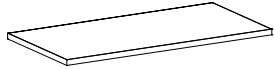

Description	Product No.	List \$	Product No.	List \$	Product No.	List \$	Product No.	List \$	Product No.	List \$	Product No.	List \$	Product No.	List \$
Metal Edge, 1.5th	20d		24d		30d		36d		42d		48d		60d	
Top/Flat OBPG: Metal 16w	DZJD2016	2091	DZJD2416	2214	DZJD3016	2399	DZJD3616	2587	DZJD4216	2773	DZJD4816	2960	DZJD6016	3333
Top/Flat OBPG: Metal 18w	DZJD2018	2160	DZJD2418	2294	DZJD3018	2495	DZJD3618	2693	DZJD4218	2893	DZJD4818	3093	DZJD6018	3493
Top/Flat OBPG: Metal 20w	DZJD2020	2232	DZJD2420	2375	DZJD3020	2588	DZJD3620	2801	DZJD4220	3016	DZJD4820	3228	DZJD6020	3657
Top/Flat OBPG: Metal 24w	DZJD2024	2375	DZJD2424	2536	DZJD3024	2776	DZJD3624	3017	DZJD4224	3257	DZJD4824	3498	DZJD6024	3981
Top/Flat OBPG: Metal 30w	DZJD2030	2588	DZJD2430	2776	DZJD3030	3058	DZJD3630	3339	DZJD4230	3621	DZJD4830	3902	DZJD6030	4467
Top/Flat OBPG: Metal 36w	DZJD2036	2801	DZJD2436	3017	DZJD3036	3339	DZJD3636	3661	DZJD4236	3985	DZJD4836	4305	DZJD6036	4953
Top/Flat OBPG: Metal 42w	DZJD2042	3016	DZJD2442	3257	DZJD3042	3621	DZJD3642	3985	DZJD4242	4349	DZJD4842	4710	DZJD6042	5438
Top/Flat OBPG: Metal 48w	DZJD2048	3228	DZJD2448	3498	DZJD3048	3902	DZJD3648	4305	DZJD4248	4710	DZJD4848	5118	DZJD6048	5925
Top/Flat OBPG: Metal 54w	DZJD2054	3442	DZJD2454	3740	DZJD3054	4184	DZJD3654	4629	DZJD4254	5074	DZJD4854	5521	DZJD6054	6409
• Top/Flat OBPG: Metal 60w	DZJD2060	3657	DZJD2460	3981	DZJD3060	4467	DZJD3660	4953	DZJD4260	5438	DZJD4860	5925	DZJD6060	6896
Top/Flat OBPG: Metal 66w	DZJD2066	3868	DZJD2466	4221	DZJD3066	4747	DZJD3666	5274	DZJD4266	5800	DZJD4866	6329	DZJD6066	7382
Top/Flat OBPG: Metal 72w	DZJD2072	4083	DZJD2472	4463	DZJD3072	5031	DZJD3672	5598	DZJD4272	6166	DZJD4872	6734	DZJD6072	7868
Top/Flat OBPG: Metal 78w	DZJD2078	4297	DZJD2478	4703	DZJD3078	5310	DZJD3678	5919	DZJD4278	6530	DZJD4878	7137	DZJD6078	8356
Top/Flat OBPG: Metal 84w	DZJD2084	4512	DZJD2484	4943	DZJD3084	5593	DZJD3684	6242	DZJD4284	6892	DZJD4884	7542	DZJD6084	8841
Top/Flat OBPG: Metal 90w	DZJD2090	4724	DZJD2490	5184	DZJD3090	5875	DZJD3690	6566	DZJD4290	7254	DZJD4890	7945	DZJD6090	9327
Top/Flat OBPG: Metal 96w	DZJD2096	4937	DZJD2496	5424	DZJD3096	6157	DZJD3696	6887	DZJD4296	7618	DZJD4896	8351	DZJD6096	9811
Top/Flat OBPG: Metal 102w	DZJD2102	5150	DZJD24102	5667	DZJD30102	6438	DZJD36102	7210	DZJD42102	7981	DZJD48102	8754	DZJD60102	10298
Top/Flat OBPG: Metal 108w	DZJD20108	5366	DZJD24108	5907	DZJD30108	6720	DZJD36108	7533	DZJD42108	8346	DZJD48108	9158	DZJD60108	10784
Top/Flat OBPG: Metal 114w	DZJD20114	5580	DZJD24114	6148	DZJD30114	7002	DZJD36114	7855	DZJD42114	8709	DZJD48114	9563	DZJD60114	11271
Top/Flat OBPG: Metal 120w	DZJD20120	5793	DZJD24120	6389	DZJD30120	7284	DZJD36120	8177	DZJD42120	9073	DZJD48120	9968	DZJD60120	11756

! Notes—Tops this page only:
 OcuWrite tops have a metal edge.
 OcuWrite Back-Painted Glass color is O.BWT White.

! Notes—All Tops:
 Metal edge finish standard as MRBAS, Brushed Aluminum w/Steel Tint.
 Metal edge will be on all edges of tops where applicable.
 Tops are 1 piece construction, so verify on larger tops that they will fit into space.

+ Options—All Tops:
 For Brush grommet/ Pencil Catch add BG to spec code and add \$7 per inch.
 Brush grommets/Pencil Catches, must be 12 inches smaller than full width of top, 6in from each end of top minimum.
 Ex. 72 inch top would get a max size brush grommet of 60 inch and the cost would be \$420.

Top Dividers

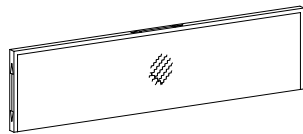

Description	COM yds	Product No.	List \$	Product No.	List \$	Product No.	List \$	Product No.	List \$
Fabric		12h		15h		20h		24h	
Fabric: Magnetic 20w	1	DZKA2012	1461	DZKA2015	1520	DZKA2020	1587	DZKA2024	1626
Fabric: Magnetic 24w	1	DZKA2412	1503	DZKA2415	1580	DZKA2420	1654	DZKA2424	1716
Fabric: Magnetic 30w	1	DZKA3012	1556	DZKA3015	1653	DZKA3020	1738	DZKA3024	1820
Fabric: Magnetic 36w	1.2	DZKA3612	1609	DZKA3615	1725	DZKA3620	1822	DZKA3624	1926
Fabric: Magnetic 42w	1.4	DZKA4212	1662	DZKA4215	1797	DZKA4220	1905	DZKA4224	2030
Fabric: Magnetic 48w	1.5	DZKA4812	1716	DZKA4815	1869	DZKA4820	1990	DZKA4824	2136
• Fabric: Magnetic 54w	1.7	DZKA5412	1767	DZKA5415	1940	DZKA5420	2073	DZKA5424	2241
Fabric: Magnetic 60w	1.9	DZKA6012	1820	DZKA6015	2014	DZKA6020	2158	DZKA6024	2346
Fabric: Magnetic 66w	2	DZKA6612	1872	DZKA6615	2085	DZKA6620	1726	DZKA6624	2453
Fabric: Magnetic 72w	2.2	DZKA7212	1926	DZKA7215	2158	DZKA7220	2325	DZKA7224	2559
Fabric: Magnetic 78w	2.4	DZKA7812	1978	DZKA7815	2229	DZKA7820	2410	DZKA7824	2664

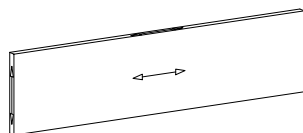

Wood		12h		15h		20h		24h	
Wood: 20w		DZKB2012	1142	DZKB2015	1181	DZKB2020	1206	DZKB2024	1216
Wood: 24w		DZKB2412	1169	DZKB2415	1216	DZKB2420	1243	DZKB2424	1265
Wood: 30w		DZKB3012	1192	DZKB3015	1255	DZKB3020	1279	DZKB3024	1317
Wood: 36w		DZKB3612	1216	DZKB3615	1293	DZKB3620	1318	DZKB3624	1365
Wood: 42w		DZKB4212	1241	DZKB4215	1328	DZKB4220	1355	DZKB4224	1413
Wood: 48w		DZKB4812	1265	DZKB4815	1365	DZKB4820	1390	DZKB4824	1464
• Wood: 54w		DZKB5412	1293	DZKB5415	1403	DZKB5420	1429	DZKB5424	1514
Wood: 60w		DZKB6012	1317	DZKB6015	1439	DZKB6020	1466	DZKB6024	1561
Wood: 66w		DZKB6612	1341	DZKB6615	1476	DZKB6620	1503	DZKB6624	1612
Wood: 72w		DZKB7212	1365	DZKB7215	1514	DZKB7220	1538	DZKB7224	1662
Wood: 78w		DZKB7812	1389	DZKB7815	1550	DZKB7820	1577	DZKB7824	1709

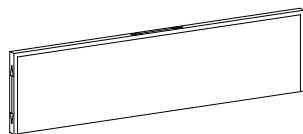

OcuWrite BPGlass		12h		15h		20h		24h	
OcuWriteBPG: Magnetic 20w		DZKC2012	2010	DZKC2015	2207	DZKC2020	2501	DZKC2024	2725
OcuWriteBPG: Magnetic 24w		DZKC2412	2162	DZKC2415	2403	DZKC2420	2750	DZKC2424	3031
OcuWriteBPG: Magnetic 30w		DZKC3012	2380	DZKC3015	2680	DZKC3020	3109	DZKC3024	3464
OcuWriteBPG: Magnetic 36w		DZKC3612	2596	DZKC3615	2960	DZKC3620	3466	DZKC3624	3900
OcuWriteBPG: Magnetic 42w		DZKC4212	2814	DZKC4215	3237	DZKC4220	3825	DZKC4224	4333
OcuWriteBPG: Magnetic 48w		DZKC4812	3031	DZKC4815	3513	DZKC4820	4183	DZKC4824	4769
• OcuWriteBPG: Magnetic 54w		DZKC5412	3247	DZKC5415	3793	DZKC5420	4541	DZKC5424	5203
OcuWriteBPG: Magnetic 60w		DZKC6012	3464	DZKC6015	4069	DZKC6020	4899	DZKC6024	5637
OcuWriteBPG: Magnetic 66w		DZKC6612	3682	DZKC6615	4349	DZKC6620	1726	DZKC6624	6072
OcuWriteBPG: Magnetic 72w		DZKC7212	3900	DZKC7215	4624	DZKC7220	5615	DZKC7224	6507
OcuWriteBPG: Magnetic 78w		DZKC7812	4116	DZKC7815	4902	DZKC7820	5971	DZKC7824	6941

! Notes:

- All Dividers are two sided.
- All Dividers have a 0.75 Wood1 edge.
- OcuWrite Back-Painted Glass color: O.BWT White.
- Fabric panels are COM.
- Glass panels and Fabric panels are magnetic.
- Dividers are 1.5 inches thick.

Hutches, Open Shelving

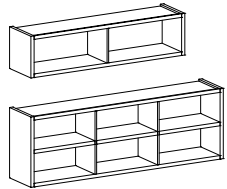

Description	Product No.	List \$	Product No.	List \$	Product No.	List \$	Product No.	List \$	Product No.	List \$	Product No.	List \$
18d	17.5h			29.5h								
Open Shelving 36w	DZLAA36	2957				DZLAB36		3838				
Open Shelving 48w	DZLAA48	3086				DZLAB48		3968				
Open Shelving 54w	DZLAA54	3150				DZLAB54		4032				
Open Shelving 60w	DZLAA60	3216				DZLAB60		4097				
Open Shelving 66w	DZLAA66	3280				DZLAB66		4198				
• Open Shelving 72w	DZLAA72	3344				DZLAB72		4300				
Open Shelving 78w	DZLAA78	3408				DZLAB78		4403				
Open Shelving 84w	DZLAA84	3474				DZLAB84		4503				
• Open Shelving 90w	DZLAA90	3539				DZLAB90		4605				
Open Shelving 96w	DZLAA96	3604				DZLAB96		4706				
Open Shelving 102w	DZLAA102	3667				DZLAB102		4810				
Open Shelving 108w	DZLAA108	3734				DZLAB108		4910				
Open Shelving 114w	DZLAA114	3799				DZLAB114		5013				
Open Shelving 120w	DZLAA120	3862				DZLAB120		5112				

Hutches, Cabinet Doors

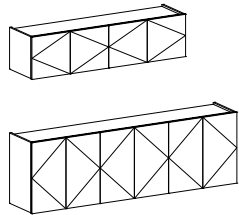

18d	#Doors	17.5h			29.5h								
		Wood1 Doors	Acrylic Doors	OcuWriteBPG Doors	Wood1 Doors	Acrylic Doors	OcuWrite BPG Doors						
Cabinet Doors 36w	2	DZLBW36	3220	DZLBA36	4319	DZLBG36	4788	DZLCW36	4101	DZLCA36	5200	DZLCG36	6054
Cabinet Doors 48w	3	DZLBW48	3415	DZLBA48	4514	DZLBG48	5024	DZLCW48	4297	DZLCA48	5395	DZLCG48	6236
Cabinet Doors 54w	3	DZLBW54	3511	DZLBA54	4610	DZLBG54	5141	DZLCW54	4392	DZLCA54	5492	DZLCG54	6325
Cabinet Doors 60w	3	DZLBW60	3608	DZLBA60	4706	DZLBG60	5261	DZLCW60	4491	DZLCA60	5588	DZLCG60	6416
Cabinet Doors 66w	4	DZLBW66	3729	DZLBA66	4826	DZLBG66	5544	DZLCW66	4624	DZLCA66	5724	DZLCG66	6764
• Cabinet Doors 72w	4	DZLBW72	3826	DZLBA72	4925	DZLBG72	5809	DZLCW72	4759	DZLCA72	5857	DZLCG72	7113
Cabinet Doors 78w	4	DZLBW78	3923	DZLBA78	5020	DZLBG78	6070	DZLCW78	4893	DZLCA78	5990	DZLCG78	7461
Cabinet Doors 84w	5	DZLBW84	4044	DZLBA84	5142	DZLBG84	6356	DZLCW84	5026	DZLCA84	6126	DZLCG84	7810
Cabinet Doors 90w	5	DZLBW90	4140	DZLBA90	6336	DZLBG90	6618	DZLCW90	5161	DZLCA90	7355	DZLCG90	8159
Cabinet Doors 96w	6	DZLBW96	4261	DZLBA96	6455	DZLBG96	6901	DZLCW96	5295	DZLCA96	7490	DZLCG96	8507
Cabinet Doors 102w	6	DZLBW102	4358	DZLBA102	6553	DZLBG102	7165	DZLCW102	5429	DZLCA102	7625	DZLCG102	8856
Cabinet Doors 108w	6	DZLBW108	4455	DZLBA108	6650	DZLBG108	7427	DZLCW108	5563	DZLCA108	7757	DZLCG108	9204
Cabinet Doors 114w	6	DZLBW114	4552	DZLBA114	6746	DZLBG114	7689	DZLCW114	5697	DZLCA114	7892	DZLCG114	9553
Cabinet Doors 120w	6	DZLBW120	4648	DZLBA120	6844	DZLBG120	7951	DZLCW120	5831	DZLCA120	8026	DZLCG120	9902

! Notes:

- Open End Options allowed on Open Shelving, Sliding Doors, and L Sliding Doors.
- For Open end left add A to the end of Product number.
- For Open end right add B to the end of the Product number.
- For Open end Both ends add C to the end of the Product number. Only allowed on 102w and greater.
- All Shelves are fixed, except for Cabinet door hutches.
- All Hutches come in one piece up to 120-in, please notify CSR if needed in 2 piece construction.
- Acrylic faces are Stylelite Arctic White standard.
- OcuWrite Back-Painted Glass color: O.BWT White.

Description	#Doors	17.5h			29.5h								
		Wood1 Doors	Acrylic Doors	OcuWrite BPG Doors	Wood1 Doors	Acrylic Doors	OcuWrite BPG Doors						
Hutches, Sliding Doors													
Sliding Doors 48w	1	DZLDW48	4138	DZLDA48	4575	DZLDG48	4997	DZLEW48	5085	DZLEA48	5523	DZLEG48	5851
Sliding Doors 54w	1	DZLDW54	4203	DZLDA54	4640	DZLDG54	5064	DZLEW54	5186	DZLEA54	5623	DZLEG54	5945
Sliding Doors 60w	1	DZLDW60	4299	DZLDA60	4736	DZLDG60	5160	DZLEW60	5290	DZLEA60	5727	DZLEG60	6040
Sliding Doors 66w	1	DZLDW66	4397	DZLDA66	4834	DZLDG66	5429	DZLEW66	5445	DZLEA66	5881	DZLEG66	6408
• Sliding Doors 72w	1	DZLDW72	4494	DZLDA72	4930	DZLDG72	5711	DZLEW72	5600	DZLEA72	6036	DZLEG72	6778
Sliding Doors 78w	2	DZLDW78	4591	DZLDA78	5026	DZLDG78	5994	DZLEW78	5757	DZLEA78	6193	DZLEG78	7146
Sliding Doors 84w	2	DZLDW84	4688	DZLDA84	5125	DZLDG84	6278	DZLEW84	5912	DZLEA84	6348	DZLEG84	7514
Sliding Doors 90w	2	DZLDW90	4784	DZLDA90	5221	DZLDG90	6601	DZLEW90	6069	DZLEA90	6939	DZLEG90	7883
Sliding Doors 96w	2	DZLDW96	4881	DZLDA96	5319	DZLDG96	6843	DZLEW96	6223	DZLEA96	7095	DZLEG96	8252
Sliding Doors 102w	2	DZLDW102	5363	DZLDA102	5800	DZLDG102	7512	DZLEW102	6764	DZLEA102	7862	DZLEG102	8979
Sliding Doors 108w	2	DZLDW108	5460	DZLDA108	5898	DZLDG108	7753	DZLEW108	6920	DZLEA108	8017	DZLEG108	9347
Sliding Doors 114w	2	DZLDW114	5559	DZLDA114	5996	DZLDG114	8037	DZLEW114	7075	DZLEA114	8174	DZLEG114	9716
Sliding Doors 120w	2	DZLDW120	5655	DZLDA120	6092	DZLDG120	8319	DZLEW120	7230	DZLEA120	8329	DZLEG120	10084

Description	#Doors	17.5h			29.5h							
		Wood1 Doors	Acrylic Doors	OcuWrite BPG Doors	Wood1 Doors	Acrylic Doors	OcuWrite BPG Doors					
Hutches, L-Sliding Door												
L- Sliding Door 48w	1	DZLFW48	4012	DZLFA48	4449	DZLFG48	4872	—	—	—	—	—
L- Sliding Door 54w	1	DZLFW54	4097	DZLFA54	4534	DZLFG54	4958	—	—	—	—	—
L- Sliding Door 60w	1	DZLFW60	4262	DZLFA60	4699	DZLFG60	5123	—	—	—	—	—
L- Sliding Door 66w	1	DZLFW66	4347	DZLFA66	4783	DZLFG66	5379	—	—	—	—	—
L- Sliding Door 72w	1	DZLFW72	4432	DZLFA72	4869	DZLFG72	5650	—	—	—	—	—
L- Sliding Door 78w	1	DZLFW78	4595	DZLFA78	5033	DZLFG78	6000	—	—	—	—	—
L- Sliding Door 84w	1	DZLFW84	4736	DZLFA84	5172	DZLFG84	6325	—	—	—	—	—
L- Sliding Door 90w	1	DZLFW90	4820	DZLFA90	5693	DZLFG90	6637	—	—	—	—	—
L- Sliding Door 96w	1	DZLFW96	5254	DZLFA96	6128	DZLFG96	7216	—	—	—	—	—
• L- Sliding Door 102w	2	DZLFW102	5339	DZLFA102	6212	DZLFG102	7488	—	—	—	—	—
L- Sliding Door 108w	2	DZLFW108	5424	DZLFA108	6296	DZLFG108	7718	—	—	—	—	—
L- Sliding Door 114w	2	DZLFW114	5697	DZLFA114	6569	DZLFG114	8175	—	—	—	—	—
L- Sliding Door 120w	2	DZLFW120	5786	DZLFA120	6657	DZLFG120	8448	—	—	—	—	—

! Notes:

- Open End Options allowed on Open Shelving, Sliding Doors, and L Sliding Doors.
- For Open end left add A to the end of Product number.
- For Open end right add B to the end of the Product number.
- For Open end Both ends add C to the end of the Product number. Only allowed on 102w and greater.
- All Shelves are fixed, except for Cabinet door hutches.
- All Hutches come in one piece up to 120-in, please notify CSR if needed in 2 piece construction.
- Acrylic faces are Stylelite Arctic White standard.
- OcuWrite Back-Painted Glass color: O.BWT White.

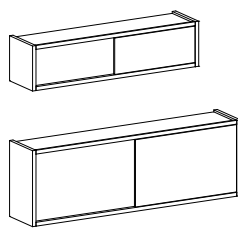
Description	Product No.	List \$	17.5h			29.5h			List \$	Product No.	List \$	Product No.	List \$	
			Product No.	List \$	Product No.	Product No.	List \$	Product No.						List \$
Hutches, BI-Pass Sliding Door 	18d		17.5h			29.5h								
		#Doors	Wood1	Doors	Acrylic	Doors	OcuWrite BPG	Doors	Wood1	Doors	Acrylic	Doors	OcuWrite BPG	Doors
	Bi-Pass SlideDr 60w	2	DZLGW60	4518	DZLGA60	5616	—	—	DZLHW60	5615	DZLHA60	6714	—	—
	Bi-Pass SlideDr 66w	2	DZLGW66	4615	DZLGA66	5712	—	—	DZLHW66	5770	DZLHA66	6868	—	—
	• Bi-Pass SlideDr 72w	2	DZLGW72	4713	DZLGA72	5812	—	—	DZLHW72	5927	DZLHA72	7025	—	—
	Bi-Pass SlideDr 78w	2	DZLGW78	4810	DZLGA78	5907	—	—	DZLHW78	6082	DZLHA78	7180	—	—
	Bi-Pass SlideDr 84w	2	DZLGW84	4906	DZLGA84	6004	—	—	DZLHW84	6237	DZLHA84	7336	—	—
	Bi-Pass SlideDr 90w	2	DZLGW90	5004	DZLGA90	7199	—	—	DZLHW90	6393	DZLHA90	8588	—	—
	Bi-Pass SlideDr 96w	2	DZLGW96	5101	DZLGA96	7295	—	—	DZLHW96	6549	DZLHA96	8743	—	—
	Bi-Pass SlideDr 102w	4	DZLGW102	5196	DZLGA102	7391	—	—	DZLHW102	6704	DZLHA102	8900	—	—
	Bi-Pass SlideDr 108w	4	DZLGW108	5295	DZLGA108	7490	—	—	DZLHW108	6861	DZLHA108	9055	—	—
	Bi-Pass SlideDr 114w	4	DZLGW114	5392	DZLGA114	7586	—	—	DZLHW114	7015	DZLHA114	9211	—	—
	Bi-Pass SlideDr 120w	4	DZLGW120	5487	DZLGA120	7684	—	—	DZLHW120	7172	DZLHA120	9367	—	—

! Notes:

Bi-Pass Door hutches DO NOT allow for Legal Redweld.
 All Shelves are fixed, except for Cabinet door hutches.
 All Hutches come in one piece up to 120-in, please notify CSR if needed in 2 piece construction.
 Acrylic faces are Stylelite Arctic White standard.
 OcuWrite Back-Painted Glass color is O.BWT White.

Task Lights for Hutches



	w	Product No.	List \$
LED Lights 36w	30	DZLED36	614
LED Lights 48w	42	DZLED48	656
LED Lights 54w	48	DZLED54	696
LED Lights 60w	54	DZLED60	738
LED Lights 66w	60	DZLED66	779
LED Lights 72w	60	DZLED72	785
LED Lights 78w	72	DZLED78	844
LED Lights 84w	72	DZLED84	853
LED Lights 90w	84	DZLED90	911
LED Lights 96w	84	DZLED96	918
LED Lights 102w	96	DZLED102	1009
LED Lights 108w	96	DZLED108	1016
LED Lights 114w	108	DZLED114	1068
LED Lights 120w	108	DZLED120	1075

! Notes:

Order lights for the size of hutch.
 Switch is a wireless dimmer, located in worksurface unless otherwise specified.
 Lights are 3500k; Inquire with Customer Service for other Kelvin Temperatures.
 5.5 Watt/Ft
 615 Lumens/Ft
 115 Degree Beam Angle
 >90 Color Rendering Index (CRI)

Description	#Shelves	Product No.	List \$	Product No.	List \$	Product No.	List \$	Product No.	List \$	Product No.	List \$	Product No.	List \$	Product No.	List \$
Wall Panels, Wood1															
	h	30w	36w	42w	48w	54w	60w	66w	72w						
Flush: Credenza: Hutch	25.1	1	DZMWA30 2620	DZMWA36 2732	DZMWA42 2844	DZMWA48 2960	DZMWA54 3072	DZMWA60 3186	DZMWA66 3297	DZMWA72 3410					
Flush: Low Credenza: Hutch	31.1	1	DZMWB30 2744	DZMWB36 2874	DZMWB42 3003	DZMWB48 3133	DZMWB54 3262	DZMWB60 3393	DZMWB66 3524	DZMWB72 3654					
Flush: Credenza: 60.5h oa	30.6	2	DZMWC30 2703	DZMWC36 2826	DZMWC42 2951	DZMWC48 3075	DZMWC54 3199	DZMWC60 3323	DZMWC66 3448	DZMWC72 3572					
Flush: Low Credenza: 60.5h oa	36.6	2	DZMWD30 2826	DZMWD36 2967	DZMWD42 3109	DZMWD48 3251	DZMWD54 3392	DZMWD60 3533	DZMWD66 3673	DZMWD72 3814					
Flush: Credenza: 72.5h oa	42.6	2	DZMWE30 2951	DZMWE36 3109	DZMWE42 3268	DZMWE48 3424	DZMWE54 3583	DZMWE60 3741	DZMWE66 3898	DZMWE72 4057					
Flush: Low Credenza: 72.5h oa	48.6	2	DZMWF30 3075	DZMWF36 3251	DZMWF42 3424	DZMWF48 3600	DZMWF54 3774	DZMWF60 3949	DZMWF66 4124	DZMWF72 4299					
Flush: Credenza: 84.5h oa	54.6	3	DZMWG30 3199	DZMWG36 3392	DZMWG42 3583	DZMWG48 3774	DZMWG54 3967	DZMWG60 4157	DZMWG66 4350	DZMWG72 4541					
Flush: Low Credenza: 84.5h oa	60.6	3	DZMWH30 3323	DZMWH36 3533	DZMWH42 3741	DZMWH48 3949	DZMWH54 4157	DZMWH60 4368	DZMWH66 4576	DZMWH72 4783					
Floor: Overhead	54.5	3	DZMWJ30 3199	DZMWJ36 3392	DZMWJ42 3583	DZMWJ48 3774	DZMWJ54 3967	DZMWJ60 4157	DZMWJ66 4350	DZMWJ72 4541					
Floor: 60.5h oa	60	4	DZMWK30 3323	DZMWK36 3533	DZMWK42 3741	DZMWK48 3949	DZMWK54 4157	DZMWK60 4368	DZMWK66 4576	DZMWK72 4783					
Floor: 72.5h oa	72	4	DZMWL30 3572	DZMWL36 3814	DZMWL42 4057	DZMWL48 4299	DZMWL54 4541	DZMWL60 4783	—	—					
Floor: 84.5h oa	84	5	DZMWM30 3821	DZMWM36 4097	DZMWM42 4373	DZMWM48 4648	DZMWM54 4925	DZMWM60 5201	—	—					
	h	78w	84w	90w	96w	102w	108w	114w	120w						
Flush: Credenza: Hutch	25.1	1	DZMWA78 3524	DZMWA84 3637	DZMWA90 3750	DZMWA96 3862	DZMWA102 3976	DZMWA108 4089	DZMWA114 4203	DZMWA120 4316					
Flush: Low Credenza: Hutch	31.1	1	DZMWB78 3783	DZMWB84 3913	DZMWB90 4043	DZMWB96 4173	DZMWB102 4303	DZMWB108 4433	DZMWB114 4562	DZMWB120 4692					
Flush: Credenza: 60.5h oa	30.6	2	DZMWC78 3696	DZMWC84 3821	DZMWC90 3947	DZMWC96 4069	DZMWC102 4195	DZMWC108 4319	DZMWC114 4444	DZMWC120 4568					
Flush: Low Credenza: 60.5h oa	36.6	2	DZMWD78 3955	DZMWD84 4097	DZMWD90 4239	DZMWD96 4380	DZMWD102 4521	DZMWD108 4663	DZMWD114 4802	DZMWD120 4943					
Flush: Credenza: 72.5h oa	42.6	2	DZMWE78 4215	DZMWE84 4373	DZMWE90 4532	DZMWE96 4689	DZMWE102 4847	DZMWE108 5006	DZMWE114 5162	DZMWE120 5321					
Flush: Low Credenza: 72.5h oa	48.6	2	DZMWF78 4473	DZMWF84 4648	DZMWF90 4824	DZMWF96 4997	DZMWF102 5174	DZMWF108 5349	DZMWF114 5523	DZMWF120 5698					
Flush: Credenza: 84.5h oa	54.6	3	DZMWG78 4733	DZMWG84 4925	DZMWG90 5118	DZMWG96 5308	DZMWG102 5501	DZMWG108 5691	DZMWG114 5882	DZMWG120 6075					
Flush: Low Credenza: 84.5h oa	60.6	3	DZMWH78 4993	DZMWH84 5201	DZMWH90 5410	DZMWH96 5618	DZMWH102 5826	DZMWH108 6035	DZMWH114 6243	DZMWH120 6453					
Floor: Overhead	54.5	3	DZMWJ78 4733	DZMWJ84 4925	DZMWJ90 5118	DZMWJ96 5308	DZMWJ102 5501	DZMWJ108 5691	DZMWJ114 5882	DZMWJ120 6075					
Floor: 60.5h oa	60	4	DZMWK78 4993	DZMWK84 5201	DZMWK90 5410	DZMWK96 5618	DZMWK102 5826	DZMWK108 6035	DZMWK114 6243	DZMWK120 6453					
Floor: 72.5h oa	72	4	—	—	—	—	—	—	—	—					
Floor: 84.5h oa	84	5	—	—	—	—	—	—	—	—					

!

Notes:

- All panels are magnetic or tackable.
- Metal shelves have a weight limit of 40 lbs per linear foot with a .25 inch drop.
- Wood shelves have a weight limit of 40 lbs per linear foot.
- Metal and Wood shelves cannot be intermixed on a single panel.
- Fabric panels width will be determined by fabric direction.
- Fabric panels over 96 inches wide will be two piece.
- Wall panels taller than 48.6h will be done in multiple sections to fit direction and size of Fabric roll.
- Any Fabric wall panel wider than 96w will be split vertically in two pieces.
- 1.5-in metal edge on 2 sides on all panels; plus top trim when not below a hutch; plus bottom trim when not on worksurface.
- Metal edge finish is MRBAS; Metal Resin Brushed Aluminum with Steel Tint.
- Max size of glass panels is 96w x 48h in one piece; max width is 96w.
- Shelf depth is 12d on both wood and metal shelves.
- Metal shelves are standard MRBAS, Brushed Aluminum w/Steel Tint.
- Number of shelves is determined by panel size.
- Specify shelf location using chart at bottom of section.
- OcuWrite Back-Painted Glass color: O.BWT White.

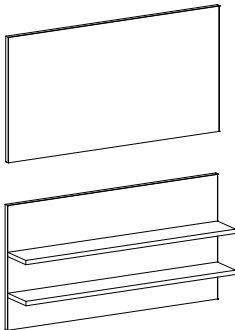

Description	#Shelves	Product No.	List \$	Product No.	List \$	Product No.	List \$	Product No.	List \$	Product No.	List \$	Product No.	List \$	Product No.	List \$	
Wall Panels, OcuWrite BPGlass																
	h	30w		36w		42w		48w		54w		60w		66w		72w
Flush: Credenza: Hutch	25.1	1	DZMGA30 2999	DZMGA36 3206	DZMGA42 3417	DZMGA48 3625	DZMGA54 3833	DZMGA60 4041	DZMGA66 4249	DZMGA72 4459						
Flush: Low Credenza: Hutch	31.1	1	DZMGB30 3294	DZMGB36 3552	DZMGB42 3808	DZMGB48 4066	DZMGB54 4322	DZMGB60 4579	DZMGB66 4835	DZMGB72 5091						
Flush: Credenza: 60.5h oa	30.6	2	DZMGC30 3197	DZMGC36 3437	DZMGC42 3678	DZMGC48 3919	DZMGC54 4159	DZMGC60 4400	DZMGC66 4641	DZMGC72 4881						
Flush: Low Credenza: 60.5h oa	36.6	2	DZMGD30 3493	DZMGD36 3782	DZMGD42 4069	DZMGD48 4359	DZMGD54 4647	DZMGD60 4937	DZMGD66 5226	DZMGD72 5514						
Flush: Credenza: 72.5h oa	42.6	2	DZMGE30 3788	DZMGE36 4125	DZMGE42 4464	DZMGE48 4801	DZMGE54 5138	DZMGE60 5474	DZMGE66 5812	DZMGE72 6148						
Flush: Low Credenza: 72.5h oa	48.6	2	DZMGF30 4086	DZMGF36 4470	DZMGF42 4857	DZMGF48 5242	DZMGF54 5626	DZMGF60 6012	DZMGF66 6397	DZMGF72 6781						
Flush: Credenza: 84.5h oa	54.6	3	DZMGG30 4382	DZMGG36 4816	DZMGG42 5249	DZMGG48 5683	DZMGG54 6114	DZMGG60 6549	DZMGG66 6980	DZMGG72 7414						
Flush: Low Credenza: 84.5h oa	60.6	3	DZMGH30 4680	DZMGH36 5161	DZMGH42 5643	DZMGH48 6124	DZMGH54 6605	DZMGH60 7086	DZMGH66 7568	DZMGH72 8049						
Floor: Overhead	54.5	3	DZMGJ30 4382	DZMGJ36 4816	DZMGJ42 5249	DZMGJ48 5683	DZMGJ54 6114	DZMGJ60 6549	DZMGJ66 6980	DZMGJ72 7414						
Floor: 60.5h oa	60	4	DZMGK30 4680	DZMGK36 5161	DZMGK42 5643	DZMGK48 6124	DZMGK54 6605	DZMGK60 7086	DZMGK66 7568	DZMGK72 8049						
Floor: 72.5h oa	72	4	DZMGL30 5272	DZMGL36 5851	DZMGL42 6427	DZMGL48 7006	DZMGL54 7582	DZMGL60 8160								
Floor: 84.5h oa	84	5	DZMGM30 5867	DZMGM36 6538	DZMGM42 7212	DZMGM48 7888	DZMGM54 8561	DZMGM60 9235								
	h	78w		84w		90w		96w		102w		108w		114w		120w
Flush: Credenza: Hutch	25.1	1	DZMGA78 4666	DZMGA84 4875	DZMGA90 5084	DZMGA96 5294										
Flush: Low Credenza: Hutch	31.1	1	DZMGB78 5349	DZMGB84 5606	DZMGB90 5862	DZMGB96 6118										
Flush: Credenza: 60.5h oa	30.6	2	DZMGC78 5123	DZMGC84 5362	DZMGC90 5603	DZMGC96 5844										
Flush: Low Credenza: 60.5h oa	36.6	2	DZMGD78 5803	DZMGD84 6092	DZMGD90 6382	DZMGD96 6669										
Flush: Credenza: 72.5h oa	42.6	2	DZMGE78 6485	DZMGE84 6822	DZMGE90 7158	DZMGE96 7496										
Flush: Low Credenza: 72.5h oa	48.6	2	DZMGF78 7168	DZMGF84 7553												
Flush: Credenza: 84.5h oa	54.6	3	DZMGG78 7849	DZMGG84 8280												
Flush: Low Credenza: 84.5h oa	60.6	3	DZMGH78 8530	DZMGH84 9012												
Floor: Overhead	54.5	3	DZMGJ78 7849	DZMGJ84 8280												
Floor: 60.5h oa	60	4	DZMGK78 8530	DZMGK84 9012												
Floor: 72.5h oa	72	4														
Floor: 84.5h oa	84	5														

! Notes:

- All panels are magnetic or tackable.
- Metal shelves have a weight limit of 40 lbs per linear foot with a .25 inch drop.
- Wood shelves have a weight limit of 40 lbs per linear foot.
- Metal and Wood cannot be intermixed on a single panel.
- Fabric panels width will be determined by fabric direction.
- Fabric panels over 96 inches wide will be two piece.
- Wall panels taller than 48.6h will be done in multiple sections to fit direction and size of Fabric roll.
- Any Fabric wall panel wider than 96w will be split vertically in two pieces.
- 1.5-in metal edge on 2 sides on all panels; plus top trim when not below a hutch; plus bottom trim when not on worksurface.
- Metal edge finish is MRBAS; Metal Resin Brushed Aluminum with Steel Tint.
- Max size of glass panels is 96w x 48h in one piece; max width is 96w.
- Shelf depth is 12d on both wood and metal shelves.
- Metal shelves are standard MRBAS, Brushed Aluminum w/Steel Tint.
- Number of shelves is determined by panel size.
- Specify shelf location using chart at bottom of section.
- OcuWrite Back-Painted Glass color: O.BWT White.

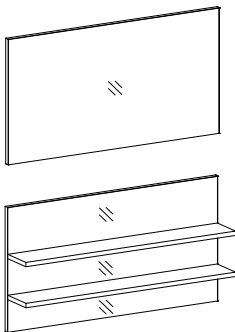

Description	#Shelves	Product No.	List \$	Product No.	List \$	Product No.	List \$	Product No.	List \$	Product No.	List \$	Product No.	List \$	Product No.	List \$			
Wall Panels, Fabric																		
	h		30w	36w	42w	48w	54w	60w	66w	72w								
Flush: Credenza: Hutch	25.1	1	DZMFA30	2227	DZMFA36	2245	DZMFA42	2262	DZMFA48	2280	DZMFA54	2295	DZMFA60	2312	DZMFA66	2330	DZMFA72	2347
Flush: Low Credenza: Hutch	31.1	1	DZMFB30	2304	DZMFB36	2325	DZMFB42	2345	DZMFB48	2366	DZMFB54	2389	DZMFB60	2411	DZMFB66	2431	DZMFB72	2453
Flush: Credenza: 60.5h oa	30.6	2	DZMFC30	2276	DZMFC36	2298	DZMFC42	2317	DZMFC48	2337	DZMFC54	2358	DZMFC60	2378	DZMFC66	2398	DZMFC72	2417
Flush: Low Credenza: 60.5h oa	36.6	2	DZMFD30	2354	DZMFD36	2378	DZMFD42	2400	DZMFD48	2426	DZMFD54	2451	DZMFD60	2473	DZMFD66	2499	DZMFD72	2523
Flush: Credenza: 72.5h oa	42.6	2	DZMFE30	2430	DZMFE36	2457	DZMFE42	2486	DZMFE48	2513	DZMFE54	2541	DZMFE60	2569	DZMFE66	2597	DZMFE72	2625
Flush: Low Credenza: 72.5h oa	48.6	2	DZMFF30	2505	DZMFF36	2538	DZMFF42	2569	DZMFF48	2601	DZMFF54	2632	DZMFF60	2665	DZMFF66	2697	DZMFF72	2730
Flush: Credenza: 84.5h oa	54.6	3	DZMFG30	2582	DZMFG36	2618	DZMFG42	2653	DZMFG48	2689	DZMFG54	2726	DZMFG60	2762	DZMFG66	2797	DZMFG72	2833
Flush: Low Credenza: 84.5h oa	60.6	3	DZMFH30	2657	DZMFH36	2696	DZMFH42	2737	DZMFH48	2777	DZMFH54	2818	DZMFH60	2857	DZMFH66	2897	DZMFH72	2938
Floor: Overhead	54.5	3	DZMFJ30	2582	DZMFJ36	2618	DZMFJ42	2653	DZMFJ48	2689	DZMFJ54	2726	DZMFJ60	2762	DZMFJ66	2797	DZMFJ72	2833
Floor: 60.5h oa	60	4	DZMFK30	2657	DZMFK36	2696	DZMFK42	2737	DZMFK48	2777	DZMFK54	—	—	—	—	—	—	—
Floor: 72.5h oa	72	4	DZMFL30	2808	DZMFL36	2856	DZMFL42	2906	DZMFL48	2952	DZMFL54	—	—	—	—	—	—	—
Floor: 84.5h oa	84	5	DZMFM30	2961	DZMFM36	3017	DZMFM42	3073	DZMFM48	3129	DZMFM54	—	—	—	—	—	—	—
	h		78w	84w	90w	96w	102w	108w	114w	120w								
Flush: Credenza: Hutch	25.1	1	DZMFA78	2365	DZMFA84	2382	DZMFA90	2400	DZMFA96	2418	DZMFA102	2436	DZMFA108	2453	DZMFA114	2471	DZMFA120	2487
Flush: Low Credenza: Hutch	31.1	1	DZMFB78	2473	DZMFB84	2495	DZMFB90	2516	DZMFB96	2538	DZMFB102	2560	DZMFB108	2581	DZMFB114	2601	DZMFB120	2623
Flush: Credenza: 60.5h oa	30.6	2	DZMFC78	2437	DZMFC84	2457	DZMFC90	2477	DZMFC96	2499	DZMFC102	2518	DZMFC108	2538	DZMFC114	2559	DZMFC120	2578
Flush: Low Credenza: 60.5h oa	36.6	2	DZMFD78	2544	DZMFD84	2569	DZMFD90	2595	DZMFD96	2618	DZMFD102	2642	DZMFD108	2667	DZMFD114	2689	DZMFD120	2713
Flush: Credenza: 72.5h oa	42.6	2	DZMFE78	2653	DZMFE84	2683	DZMFE90	2709	DZMFE96	2738	DZMFE102	2766	DZMFE108	2794	DZMFE114	2821	DZMFE120	2850
Flush: Low Credenza: 72.5h oa	48.6	2	DZMFF78	2762	DZMFF84	2794	DZMFF90	2826	DZMFF96	2857	DZMFF102	2890	DZMFF108	2921	DZMFF114	2952	DZMFF120	2986
Flush: Credenza: 84.5h oa	54.6	3	DZMFG78	2871	DZMFG84	2906	DZMFG90	2942	DZMFG96	2978	DZMFG102	3015	DZMFG108	3050	DZMFG114	3086	DZMFG120	3122
Flush: Low Credenza: 84.5h oa	60.6	3	DZMFH78	2978	DZMFH84	3019	DZMFH90	3057	DZMFH96	3096	DZMFH102	3137	DZMFH108	3178	DZMFH114	3219	DZMFH120	3257
Floor: Overhead	54.5	3	DZMFJ78	2871	DZMFJ84	2906	DZMFJ90	2942	DZMFJ96	2978	DZMFJ102	3015	DZMFJ108	3050	DZMFJ114	3086	DZMFJ120	3122
Floor: 60.5h oa	60	4	—	—	—	—	—	—	—	—	—	—	—	—	—	—	—	—
Floor: 72.5h oa	72	4	—	—	—	—	—	—	—	—	—	—	—	—	—	—	—	—
Floor: 84.5h oa	84	5	—	—	—	—	—	—	—	—	—	—	—	—	—	—	—	—

COM Fabric Requirements (yards of 54w material)

		30w	36w	48w	54w	60w	66w	72w	78w	84w	90w	96w	102w	108w	114w	120w
	25.1	1	1.2	1.5	1.7	1.9	2.2	2.2	2.4	2.5	2.7	2.9	3.2	3.4	3.5	3.7
	31.1	1	1.2	1.5	1.7	1.9	2.2	2.2	2.4	2.5	2.7	2.9	3.2	3.4	3.5	3.7
	30.6	2	2.4	3	3.4	3.8	4.4	4.4	4.8	5	5.4	5.8	6.4	6.8	7	7.4
	36.6	2	2.4	3	3.4	3.8	4.4	4.4	4.8	5	5.4	5.8	6.4	6.8	7	7.4
	42.6	2	2.4	3	3.4	3.8	4.4	4.4	4.8	5	5.4	5.8	6.4	6.8	7	7.4
	48.6	2	2.4	3	3.4	3.8	4.4	4.4	4.8	5	5.4	5.8	6.4	6.8	7	7.4
	54.6	2	2.4	3	3.4	3.8	4.4	4.4	4.8	5	5.4	5.8	6.4	6.8	7	7.4
	60.6	2	2.4	3	3.4	3.8	4.4	4.4	4.8	5	5.4	5.8	6.4	6.8	7	7.4
	54.5	2	2.4	3	3.4	3.8	4.4	4.4	4.8	5	5.4	5.8	6.4	6.8	7	7.4
	60	2	2.4	3	3.4	3.8	4.4	4.4	4.8	5	5.4	5.8	6.4	6.8	7	7.4
	72	3	3.6	4.5	5.1	5.7	6.6	6.6	7.2	7.5	8.1	8.7	9.6	10.2	10.5	11.1
	84	3	3.6	4.5	5.1	5.7	6.6	6.6	7.2	7.5	8.1	8.7	9.6	10.2	10.5	11.1

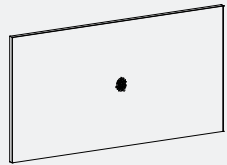

See Notes on the following page for specification information.

Shelves

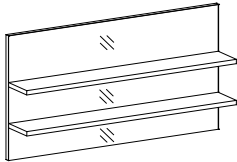

Description	Product No.		List \$	
	Wood 1.5th		Metal 0.25th	
Shelf 30w 12d	DZMSW30	1115	DZMSM30	1201
Shelf 36w 12d	DZMSW36	1154	DZMSM36	1281
Shelf 48w 12d	DZMSW48	1311	DZMSM48	1388
Shelf 54w 12d	DZMSW54	1351	DZMSM54	1388
Shelf 60w 12d	DZMSW60	1466	DZMSM60	1388
Shelf 66w 12d	DZMSW66	1506	DZMSM66	1468
Shelf 72w 12d	DZMSW72	1545	DZMSM72	1468
Shelf 78w 12d	DZMSW78	1661	DZMSM78	1468
Shelf 84w 12d	DZMSW84	1702	DZMSM84	1549
Shelf 90w 12d	DZMSW90	1742	DZMSM90	1549
Shelf 96w 12d	DZMSW96	1856	DZMSM96	1789
Shelf 102w 12d	DZMSW102	1897	DZMSM102	1789
Shelf 108w 12d	DZMSW108	1937	DZMSM108	1789
Shelf 114w 12d	DZMSW114	2052	DZMSM114	1843
Shelf 120w 12d	DZMSW120	2094	DZMSM120	1843

! Notes—for Wall Panels and Shelves:

- All panels are magnetic or tackable.
- Metal shelves have a weight limit of 40 lbs per linear foot with a .25 inch drop.
- Wood shelves have a weight limit of 40 lbs per linear foot.
- Metal and Wood cannot be intermixed on a single panel.
- Fabric panels width will be determined by fabric direction.
- Fabric panels over 96 inches wide will be two piece.
- Wall panels taller than 48.6h will be done in multiple sections to fit direction and size of Fabric roll.
- Any Fabric wall panel wider than 96w will be split vertically in two pieces.
- 1.5-in metal edge on 2 sides on all panels; plus top trim when not below a hutch; plus bottom trim when not on worksurface.
- Metal edge finish is MRBAS; Metal Resin Brushed Aluminum with Steel Tint.
- Max size of glass panels is 96w x 48h in one piece; max width is 96w.
- Shelf depth is 12d on both wood and metal shelves.
- Metal shelves are standard MRBAS, Brushed Aluminum w/Steel Tint.
- Number of shelves is determined by panel size.
- Specify shelf location using chart at bottom of section.
- OcuWrite Back-Painted Glass color: O.BWT White.

Towers Lateral Files

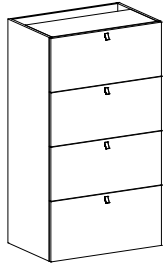

Description	Product No.	List \$	Product No.	List \$		
	20d		24d			
Tower	DZTLA	sum	DZTLB	sum		
Tower with Toe Kick	DZTLATK	sum	DZTLBTK	sum		
	Spec Code		Spec Code	Spec Code	Add \$	
	Wood1 Faces	▲	Wood1 Faces	▲	Acrylic Faces	
LatFile 3-High 24w 41.5h	3H24	3129	3H24	3394	A	+1072
LatFile 3-High 30w 41.5h	3H30	3332	3H30	3602	A	+1072
LatFile 3-High 36w 41.5h	3H36	3462	3H36	3734	A	+1072
LatFile 4-High 24w 54.75h	4H24	3584	4H24	3932	A	+1072
LatFile 4-High 30w 54.75h	4H30	3852	4H30	4207	A	+1072
LatFile 4-High 36w 54.75h	4H36	4019	4H36	4375	A	+1072

! Notes:

File towers must be anchored to wall or back to back.

Tower tops are unfinished, top must be purchased from top chart above.

Pull finish is standard MRBAS, Brushed Aluminum w/Steel tint; for polished specify MPA, Polished Aluminum.

For Drawer locks, specify LG add \$263.

Acrylic faces are Stylelite Arctic White standard.

Towers 60.5h

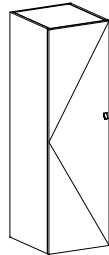
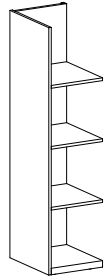
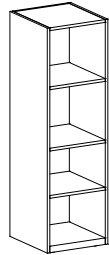

Description	Product No.	List \$	Product No.	List \$
	20d		24d	
Tower 60.5	DZT60A	sum	DZT60B	sum
Tower 60.5 with Toe Kick	DZT60ATK	sum	DZT60BTK	sum

	Spec Code		Spec Code		Spec Code	Add \$	Spec Code	Add \$
	Wood1 Faces	▲	Wood1 Faces	▲	Acrylic Faces		Mirror	
Shelving 16w	A16	2733	A16	3093	—	—	—	—
• Shelving 18w	A18	2804	A18	3180	—	—	—	—
Shelving 20w	A20	2911	A20	3306	—	—	—	—
Shelving 24w	A24	3035	A24	3465	—	—	—	—
Shelving 30w	A30	3264	A30	3750	—	—	—	—
Shelving 36w	A36	3495	A36	4036	—	—	—	—
Corner Shelving 16w LH	BL16	2412	BL16	2661	—	—	—	—
Corner Shelving 16w RH	BR16	2412	BR16	2661	—	—	—	—
Corner Shelving 18w LH	BL18	2481	BL18	2749	—	—	—	—
Corner Shelving 18w RH	BR18	2481	BR18	2749	—	—	—	—
Corner Shelving 20w LH	BL20	2588	BL20	2875	—	—	—	—
• Corner Shelving 20w RH	BR20	2588	BR20	2875	—	—	—	—
Cabinet 16w LH	CL16	2978	CL16	3336	A	+1098	—	—
Cabinet 16w RH	CR16	2978	CR16	3336	A	+1098	—	—
• Cabinet 18w LH	CL18	3103	CL18	3480	A	+1098	—	—
Cabinet 18w RH	CR18	3103	CR18	3480	A	+1098	—	—
Cabinet 20w LH	CL20	3261	CL20	3658	A	+1098	—	—
Cabinet 20w RH	CR20	3261	CR20	3658	A	+1098	—	—
Cabinet 24w LH	CL24	3487	CL24	3918	A	+1098	—	—
Cabinet 24w RH	CR24	3487	CR24	3918	A	+1098	—	—
Cabinet 30w DBL	C30	3663	C30	4095	A	+1098	—	—
Cabinet 36w DBL	C36	3841	C36	4271	A	+1098	—	—

(listing continued on following page)

! Notes:

- All units have unfinished backs.
- LH and RH designations indicate hinge side on the single door units.
- 60.5 units have finished tops, all other heights have unfinished tops.
- Corner shelving units must be secured to wall with cleat provided, or to adjoining units (i.e., pedestals or towers).
- For units with toe kick use prefix with toe kick.
- Toe kick finish is standard MRBAS, Brushed Aluminum w/Steel Tint; for polished specify MPA, Polished Aluminum.
- Pull finish is standard MRBAS, Brushed Aluminum w/Steel tint; for polished specify MPA, Polished Aluminum.
- Acrylic faces are Stylelite Arctic White standard.

Towers 60.5h (continued)

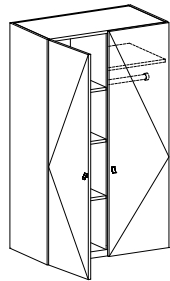
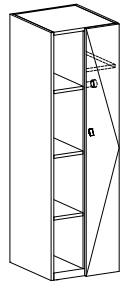

Description	Product No.		List \$		Product No.		List \$					
	20d		24d									
	Spec Code	Wood1	Faces	▲	Spec Code	Wood1	Faces	▲				
	Spec Code	Acrylic	Faces		Spec Code	Add \$	Spec Code	Add \$				
							Mirror					
Grmt8:Shv8 16w LH	DL16				DL16	3192	DL16	3660	A	+1098	MR	—
Shv8:Grmt8 16w RH	DR16				DR16	3192	DR16	3660	A	+1098	MR	—
Grmt9:Shv9 18w LH	DL18				DL18	3284	DL18	3758	A	+1098	MR	—
• Shv9:Grmt9 18w RH	DR18				DR18	3284	DR18	3758	A	+1098	MR	—
Grmt10:Shv10 20w LH	DL20				DL20	3361	DL20	3841	A	+1098	MR	—
Shv10:Grmt10 20w RH	DR20				DR20	3361	DR20	3841	A	+1098	MR	—
Grmt12:Shv12 24w LH	DL24				DL24	3419	DL24	3914	A	+1098	MR	—
Shv12:Grmt12 24w RH	DR24				DR24	3419	DR24	3914	A	+1098	MR	—
Grmt15:Shv15 30w LH	DL30				DL30	3681	DL30	4206	A	+1098	MR	+161
Shv15:Grmt15 30w RH	DR30				DR30	3681	DR30	4206	A	+1098	MR	+161
Grmt18:Shv18 36w LH	DL36				DL36	3794	DL36	4332	A	+1098	MR	+260
Shv18:Grmt18 36w RH	DR36				DR36	3794	DR36	4332	A	+1098	MR	+260
Grmt8:Cab8 16w LH	EL16				EL16	3322	EL16	3767	A	+1098	MR	+131
Cab8:Grmt8 16w RH	ER16				ER16	3322	ER16	3767	A	+1098	MR	+131
Grmt9:Cab9 18w LH	EL18				EL18	3393	EL18	3866	A	+1098	MR	+147
Cab9:Grmt9 18w RH	ER18				ER18	3393	ER18	3866	A	+1098	MR	+147
Grmt10:Cab10 20w LH	EL20				EL20	3521	EL20	3894	A	+1098	MR	+164
Cab10:Grmt10 20w RH	ER20				ER20	3521	ER20	3894	A	+1098	MR	+164
Grmt12:Cab12 24w DBL	EA24				EA24	3681	EA24	4177	A	+1098	MR	—
Cab12:Grmt12 24w DBL	EB24				EB24	3681	EB24	4177	A	+1098	MR	—
Grmt15:Cab15 30w DBL	EA30				EA30	3858	EA30	4468	A	+1098	MR	+245
Cab15:Grmt15 30w DBL	EB30				EB30	3858	EB30	4468	A	+1098	MR	+245
Grmt18:Cab18 36w DBL	EA36				EA36	4033	EA36	4645	A	+1098	MR	+260
• Cab18:Grmt18 36w DBL	EB36				EB36	4033	EB36	4645	A	+1098	MR	+260

(listing continued on following page)

! Notes:

- All units have unfinished backs.
- LH and RH designations indicate hinge side on the single door units.
- 60.5 units have finished tops, all other heights have unfinished tops.
- Corner shelving units must be secured to wall with cleat provided, or to adjoining units (i.e., pedestals or towers).
- For units with toe kick use prefix with toe kick.
- Toe kick finish is standard MRBAS, Brushed Aluminum w/Steel Tint; for polished specify MPA, Polished Aluminum.
- Pull finish is standard MRBAS, Brushed Aluminum w/Steel tint; for polished specify MPA, Polished Aluminum.
- Acrylic faces are Stylelite Arctic White standard.

+ Options:

- To specify Acrylic faces add A to spec code and add \$ total amount.
- To specify mirror add MR to spec code and add \$ amount to total.
- For Door/Cabinet locks, specify LD; add \$221.
- For Drawer locks, specify LG add \$263.

Towers 60.5h (continued)

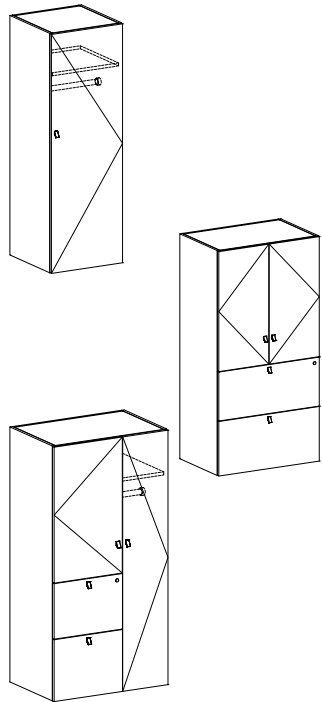

Description	Product No. 20d		Product No. 24d		Spec Code Acrylic Faces	Add \$	Spec Code Mirror	Add \$
	Spec Code Wood1 Faces	▲	Spec Code Wood1 Faces	▲				
Garment 16w LH	GL16	2804	GL16	3108	A	+1098	MR	+131
Garment 16w RH	GR16	2804	GR16	3108	A	+1098	MR	+131
Garment 18w LH	GL18	2907	GL18	3220	A	+1098	MR	+147
Garment 18w RH	GR18	2907	GR18	3220	A	+1098	MR	+147
Garment 20w LH	GL20	3048	GL20	3369	A	+1098	MR	+164
• Garment 20w RH	GR20	3048	GR20	3369	A	+1098	MR	+164
Garment 24w LH	GL24	3222	GL24	3547	A	+1098	MR	+196
Garment 24w RH	GR24	3222	GR24	3547	A	+1098	MR	+196
Cab2:2File 16w LH	HL16	3626	HL16	4038	A	+1098	MR	—
Cab2:2File 16w RH	HR16	3626	HR16	4038	A	+1098	MR	—
Cab2:2File 18w LH	HL18	3729	HL18	4120	A	+1098	MR	—
Cab2:2File 18w RH	HR18	3729	HR18	4120	A	+1098	MR	—
Cab2:2File 20w LH	HL20	3891	HL20	4326	A	+1098	MR	—
Cab2:2File 20w RH	HR20	3891	HR20	4326	A	+1098	MR	—
Cab2:2File 24w DBL	H24	4086	H24	4547	A	+1098	MR	—
• Cab2:2File 30w DBL	H30	4337	H30	4802	A	+1098	MR	—
Cab2:2File 36w DBL	H36	4552	H36	5017	A	+1098	MR	—
Cab2/2File 16:Grmt8 24w DBL	JA24	4372	JA24	4936	A	+1098	MR	—
Grmt8:Cab2/2File 16 24w DBL	JB24	4372	JB24	4936	A	+1098	MR	—
Cab2/2File 18:Grmt12 30w DBL	JA30	4551	JA30	5139	A	+1098	MR	+245
Grmt12:Cab2/2File 18 30w DBL	JB30	4551	JB30	5139	A	+1098	MR	+245
• Cab2/2File 18:Grmt18 36w DBL	JA36	4727	JA36	5315	A	+1098	MR	+260
Grmt18:Cab2/2File 18 36w DBL	JB36	4727	JB36	5315	A	+1098	MR	+260

! Notes:

All units have unfinished backs.
 LH and RH designations indicate hinge side on the single door units.
 60.5 units have finished tops, all other heights have unfinished tops.
 Corner shelving units must be secured to wall with cleat provided, or to adjoining units (i.e., pedestals or towers).
 For units with toe kick use prefix with toe kick.
 Toe kick finish is standard MRBAS, Brushed Aluminum w/Steel Tint; for polished specify MPA, Polished Aluminum.
 Pull finish is standard MRBAS, Brushed Aluminum w/Steel tint; for polished specify MPA, Polished Aluminum.
 Acrylic faces are Stylelite Arctic White standard.

+ Options:

To specify Acrylic faces add A to spec code and add \$ total amount.
 To specify mirror add MR to spec code and add \$ amount to total.
 For Door/Cabinet locks, specify LD; add \$221.
 For Drawer locks, specify LG add \$263.

Towers 72.5h

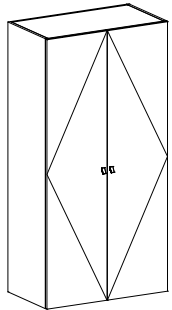
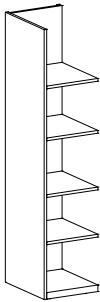
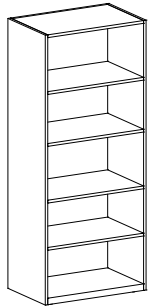

Description	Product No.		List \$	
	20d	24d		
Tower 72.5	DZT72A	sum	DZT72B	sum
Tower 72.5 with Toe Kick	DZT72ATK	sum	DZT72BTK	sum

	Spec Code	Wood1	Faces	▲	Spec Code	Wood1	Faces	▲	Spec Code	Acrylic	Faces	Add \$	Spec Code	Mirror	Add \$
Shelving 16w	A16	3096	A16	3528	—	—	—	—	—	—	—	—	—	—	—
Shelving 18w	A18	3191	A18	3644	—	—	—	—	—	—	—	—	—	—	—
Shelving 20w	A20	3310	A20	3783	—	—	—	—	—	—	—	—	—	—	—
Shelving 24w	A24	3466	A24	3986	—	—	—	—	—	—	—	—	—	—	—
• Shelving 30w	A30	3746	A30	4327	—	—	—	—	—	—	—	—	—	—	—
Shelving 36w	A36	4024	A36	4669	—	—	—	—	—	—	—	—	—	—	—
Corner Shelving 16w LH	BL16	2623	BL16	2895	—	—	—	—	—	—	—	—	—	—	—
• Corner Shelving 16w RH	BR16	2623	BR16	2895	—	—	—	—	—	—	—	—	—	—	—
Corner Shelving 18w LH	BL18	2707	BL18	2998	—	—	—	—	—	—	—	—	—	—	—
Corner Shelving 18w RH	BR18	2707	BR18	2998	—	—	—	—	—	—	—	—	—	—	—
Corner Shelving 20w LH	BL20	2814	BL20	3123	—	—	—	—	—	—	—	—	—	—	—
Corner Shelving 20w RH	BR20	2814	BR20	3123	—	—	—	—	—	—	—	—	—	—	—
Cabinet 16w LH	CL16	3317	CL16	3719	A	+1098	—	—	—	—	—	—	—	—	—
Cabinet 16w RH	CR16	3317	CR16	3719	A	+1098	—	—	—	—	—	—	—	—	—
Cabinet 18w LH	CL18	3477	CL18	3897	A	+1098	—	—	—	—	—	—	—	—	—
Cabinet 18w RH	CR18	3477	CR18	3897	A	+1098	—	—	—	—	—	—	—	—	—
Cabinet 20w LH	CL20	3637	CL20	4075	A	+1098	—	—	—	—	—	—	—	—	—
Cabinet 20w RH	CR20	3637	CR20	4075	A	+1098	—	—	—	—	—	—	—	—	—
Cabinet 24w LH	CL24	3909	CL24	4382	A	+1098	—	—	—	—	—	—	—	—	—
Cabinet 24w RH	CR24	3909	CR24	4382	A	+1098	—	—	—	—	—	—	—	—	—
• Cabinet 30w DBL	C30	4120	C30	4595	A	+1098	—	—	—	—	—	—	—	—	—
Cabinet 36w DBL	C36	4333	C36	4808	A	+1098	—	—	—	—	—	—	—	—	—

(listing continued on following page)

! Notes:

- All units have unfinished backs.
- LH and RH designations indicate hinge side on the single door units.
- 72.5h units have unfinished tops.
- Corner shelving units must be secured to wall with cleat provided, or to adjoining units (i.e., pedestals or towers).
- For units with toe kick use prefix with toe kick.
- Toe kick finish is standard MRBAS, Brushed Aluminum w/Steel Tint; for polished specify MPA, Polished Aluminum.
- Pull finish is standard MRBAS, Brushed Aluminum w/Steel tint; for polished specify MPA, Polished Aluminum.
- Acrylic faces are Stylelite Arctic White standard.

+ Options:

- To specify Acrylic faces add A to spec code and add \$ total amount.
- To specify mirror add MR to spec code and add \$ amount to total.
- For Door/Cabinet locks, specify LD; add \$221.
- For Drawer locks, specify LG add \$263.

Towers 72.5h (continued)

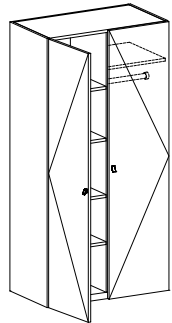
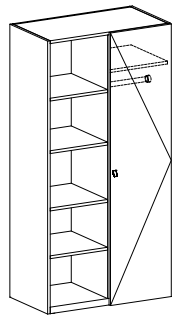

Description	Product No. 20d		Product No. 24d		Spec Code Acrylic Faces	Add \$	Spec Code Mirror	Add \$
	Spec Code Wood1 Faces	▲	Spec Code Wood1 Faces	▲				
Grmt8:Shv8 16w LH	DL16	3640	DL16	4195	A	+1098	MR	—
Shv8:Grmt8 16w RH	DR16	3640	DR16	4195	A	+1098	MR	—
Grmt9:Shv9 18w LH	DL18	3767	DL18	4327	A	+1098	MR	—
Shv9:Grmt9 18w RH	DR18	3767	DR18	4327	A	+1098	MR	—
Grmt10:Shv10 20w LH	DL20	3842	DL20	4410	A	+1098	MR	—
Shv10:Grmt10 20w RH	DR20	3842	DR20	4410	A	+1098	MR	—
Grmt12:Shv12 24w LH	DL24	3915	DL24	4498	A	+1098	MR	—
• Shv12:Grmt12 24w RH	DR24	3915	DR24	4498	A	+1098	MR	—
Grmt15:Shv15 30w LH	DL30	4235	DL30	4853	A	+1098	MR	+290
Shv15:Grmt15 30w RH	DR30	4235	DR30	4853	A	+1098	MR	+290
Grmt18:Shv18 36w LH	DL36	4372	DL36	5009	A	+1098	MR	+309
Shv18:Grmt18 36w RH	DR36	4372	DR36	5009	A	+1098	MR	+309
Grmt8:Cab8 16w LH	EL16	3793	EL16	4323	A	+1098	MR	+153
Cab8:Grmt8 16w RH	ER16	3793	ER16	4323	A	+1098	MR	+153
Grmt9:Cab9 18w LH	EL18	3897	EL18	4458	A	+1098	MR	+172
Cab9:Grmt9 18w RH	ER18	3897	ER18	4458	A	+1098	MR	+172
Grmt10:Cab10 20w LH	EL20	4026	EL20	4593	A	+1098	MR	+194
Cab10:Grmt10 20w RH	ER20	4026	ER20	4593	A	+1098	MR	+194
Grmt12:Cab12 24w DBL	EA24	4233	EA24	4815	A	+1098	MR	—
Cab12:Grmt12 24w DBL	EB24	4233	EB24	4815	A	+1098	MR	—
Grmt15:Cab15 30w DBL	EA30	4445	EA30	5171	A	+1098	MR	+290
Cab15:Grmt15 30w DBL	EB30	4445	EB30	5171	A	+1098	MR	+290
Grmt18:Cab18 36w DBL	EA36	4657	EA36	5383	A	+1098	MR	+309
• Cab18:Grmt18 36w DBL	EB36	4657	EB36	5383	A	+1098	MR	+309

(listing continued on following page)

! Notes:

- All units have unfinished backs.
- LH and RH designations indicate hinge side on the single door units.
- 72.5h units have unfinished tops.
- For units with toe kick use prefix with toe kick.
- Toe kick finish is standard MRBAS, Brushed Aluminum w/Steel Tint; for polished specify MPA, Polished Aluminum.
- Pull finish is standard MRBAS, Brushed Aluminum w/Steel tint; for polished specify MPA, Polished Aluminum.
- Acrylic faces are Stylelite Arctic White standard.

+ Options:

- To specify Acrylic faces add A to spec code and add \$ total amount.
- To specify mirror add MR to spec code and add \$ amount to total.
- For Door/Cabinet locks, specify LD; add \$221.
- For Drawer locks, specify LG add \$263.

Towers 72.5h (continued)

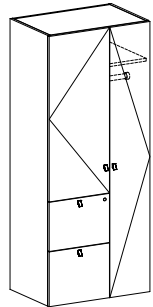
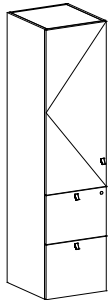
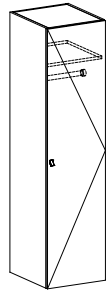

Description	Product No.		List \$		Product No.		List \$	
	20d		24d					
	Spec Code	↑	Spec Code	↑	Spec Code	Add \$	Spec Code	Add \$
	Wood1 Faces		Wood1 Faces		Acrylic Faces		Mirror	
Garment 16w LH	GL16	3145	GL16	3489	A	+1098	MR	+153
Garment 16w RH	GR16	3145	GR16	3489	A	+1098	MR	+153
Garment 18w LH	GL18	3282	GL18	3637	A	+1098	MR	+172
• Garment 18w RH	GR18	3282	GR18	3637	A	+1098	MR	+172
Garment 20w LH	GL20	3422	GL20	3787	A	+1098	MR	+194
Garment 20w RH	GR20	3422	GR20	3787	A	+1098	MR	+194
Garment 24w LH	GL24	3634	GL24	4002	A	+1098	MR	+231
Garment 24w RH	GR24	3634	GR24	4002	A	+1098	MR	+231
Cab3:2File 16w LH	HL16	3997	HL16	4496	A	+1098	MR	—
Cab3:2File 16w RH	HR16	3997	HR16	4496	A	+1098	MR	—
• Cab3:2File 18w LH	HL18	4149	HL18	4627	A	+1098	MR	—
Cab3:2File 18w RH	HR18	4149	HR18	4627	A	+1098	MR	—
Cab3:2File 20w LH	HL20	4320	HL20	4847	A	+1098	MR	—
Cab3:2File 20w RH	HR20	4320	HR20	4847	A	+1098	MR	—
Cab3:2File 24w DBL	H24	4595	H24	5142	A	+1098	MR	—
Cab3:2File 30w DBL	H30	4881	H30	5434	A	+1098	MR	—
Cab3:2File 36w DBL	H36	5131	H36	5685	A	+1098	MR	—
Cab3/2File 16:Grmt8 24w DBL	JA24	4881	JA24	5531	A	+1098	MR	—
Grmt8:Cab3/2File 16 24w DBL	JB24	4881	JB24	5531	A	+1098	MR	—
Cab3/2File 18:Grmt12 30w DBL	JA30	5095	JA30	5799	A	+1098	MR	+290
Grmt12:Cab3/2File 18 30w DBL	JB30	5095	JB30	5799	A	+1098	MR	+290
• Cab3/2File 18:Grmt18 36w DBL	JA36	5307	JA36	6012	A	+1098	MR	+309
Grmt18:Cab3/2File 18 36w DBL	JB36	5307	JB36	6012	A	+1098	MR	+309

! Notes:

- All units have unfinished backs.
- LH and RH designations indicate hinge side on the single door units.
- 72.5h units have unfinished tops.
- For units with toe kick use prefix with toe kick.
- Toe kick finish is standard MRBAS, Brushed Aluminum w/Steel Tint; for polished specify MPA, Polished Aluminum.
- Pull finish is standard MRBAS, Brushed Aluminum w/Steel tint; for polished specify MPA, Polished Aluminum.
- Acrylic faces are Stylelite Arctic White standard.

+ Options:

- To specify Acrylic faces add A to spec code and add \$ total amount.
- To specify mirror add MR to spec code and add \$ amount to total.
- For Door/Cabinet locks, specify LD; add \$221.
- For Drawer locks, specify LG add \$263.

Towers 84.5h

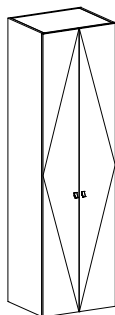
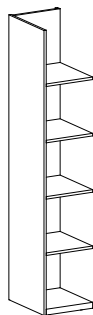
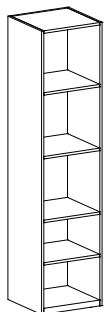

Description	Product No.	List \$	Product No.	List \$
	20d		24d	
Tower 84.5	DZT84A	sum	DZT84B	sum
Tower 84.5 with Toe Kick	DZT84ATK	sum	DZT84BTK	sum

	Spec Code		Spec Code		Spec Code	Add \$	Spec Code	Add \$
	Wood1 Faces	▲	Wood1 Faces	▲	Acrylic Faces		Mirror	
Shelving 16w	A16	3584	A16	4059	—	—	—	—
Shelving 18w	A18	3693	A18	4187	—	—	—	—
• Shelving 20w	A20	3808	A20	4327	—	—	—	—
Shelving 24w	A24	3983	A24	4543	—	—	—	—
Shelving 30w	A30	4272	A30	4899	—	—	—	—
Shelving 36w	A36	4563	A36	5253	—	—	—	—
Corner Shelving 16w LH	BL16	3045	BL16	3339	—	—	—	—
• Corner Shelving 16w RH	BR16	3045	BR16	3339	—	—	—	—
Corner Shelving 18w LH	BL18	3143	BL18	3455	—	—	—	—
Corner Shelving 18w RH	BR18	3143	BR18	3455	—	—	—	—
Corner Shelving 20w LH	BL20	3250	BL20	3581	—	—	—	—
Corner Shelving 20w RH	BR20	3250	BR20	3581	—	—	—	—
Cabinet 16w LH	CL16	3700	CL16	4148	A	+1098	—	—
Cabinet 16w RH	CR16	3700	CR16	4148	A	+1098	—	—
Cabinet 18w LH	CL18	3896	CL18	4359	A	+1098	—	—
Cabinet 18w RH	CR18	3896	CR18	4359	A	+1098	—	—
Cabinet 20w LH	CL20	4056	CL20	4538	A	+1098	—	—
Cabinet 20w RH	CR20	4056	CR20	4538	A	+1098	—	—
Cabinet 24w LH	CL24	4362	CL24	4881	A	+1098	—	—
Cabinet 24w RH	CR24	4362	CR24	4881	A	+1098	—	—
• Cabinet 30w DBL	C30	4611	C30	5127	A	+1098	—	—
Cabinet 36w DBL	C36	4859	C36	5377	A	+1098	—	—

(listing continued on following page)

! Notes:

- All units have unfinished backs.
- LH and RH designations indicate hinge side on the single door units.
- 84.5h units have unfinished tops.
- Corner shelving units must be secured to wall with cleat provided, or to adjoining units (i.e., pedestals or towers).
- For units with toe kick use prefix with toe kick.
- Toe kick finish is standard MRBAS, Brushed Aluminum w/Steel Tint; for polished specify MPA, Polished Aluminum.
- Pull finish is standard MRBAS, Brushed Aluminum w/Steel tint; for polished specify MPA, Polished Aluminum.
- Acrylic faces are Stylelite Arctic White standard.

+ Options:

- To specify Acrylic faces add A to spec code and add \$ total amount.
- To specify mirror add MR to spec code and add \$ amount to total.
- For Door/Cabinet locks, specify LD; add \$221.
- For Drawer locks, specify LG add \$263.

Towers 84.5h (continued)

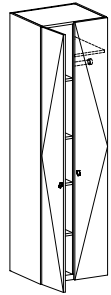
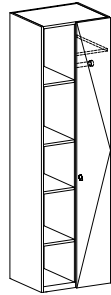

Description	Product No.		List \$		Product No.		List \$					
	20d		24d		20d		24d					
	Spec Code	Wood1	Faces	▲	Spec Code	Wood1	Faces	▲	Spec Code	Add \$	Spec Code	Add \$
									Acrylic		Mirror	
Grmt8:Shv8 16w LH	DL16			4067	DL16			4686	A	+1098	MR	—
Shv8:Grmt8 16w RH	DR16			4067	DR16			4686	A	+1098	MR	—
Grmt9:Shv9 18w LH	DL18			4230	DL18			4854	A	+1098	MR	—
Shv9:Grmt9 18w RH	DR18			4230	DR18			4854	A	+1098	MR	—
Grmt10:Shv10 20w LH	DL20			4304	DL20			4937	A	+1098	MR	—
Shv10:Grmt10 20w RH	DR20			4304	DR20			4937	A	+1098	MR	—
Grmt12:Shv12 24w LH	DL24			4391	DL24			5038	A	+1098	MR	—
• Shv12:Grmt12 24w RH	DR24			4391	DR24			5038	A	+1098	MR	—
Grmt15:Shv15 30w LH	DL30			4746	DL30			5429	A	+1098	MR	+333
Shv15:Grmt15 30w RH	DR30			4746	DR30			5429	A	+1098	MR	+333
Grmt18:Shv18 36w LH	DL36			4898	DL36			5598	A	+1098	MR	+355
Shv18:Grmt18 36w RH	DR36			4898	DR36			5598	A	+1098	MR	+355
Grmt8:Cab8 16w LH	EL16			4240	EL16			4836	A	+1098	MR	+177
Cab8:Grmt8 16w RH	ER16			4240	ER16			4836	A	+1098	MR	+177
Grmt9:Cab9 18w LH	EL18			4381	EL18			5007	A	+1098	MR	+201
Cab9:Grmt9 18w RH	ER18			4381	ER18			5007	A	+1098	MR	+201
Grmt10:Cab10 20w LH	EL20			4509	EL20			5142	A	+1098	MR	+223
Cab10:Grmt10 20w RH	ER20			4509	ER20			5142	A	+1098	MR	+223
• Grmt12:Cab12 24w DBL	EA24			4752	EA24			5398	A	+1098	MR	—
Cab12:Grmt12 24w DBL	EB24			4752	EB24			5398	A	+1098	MR	—
Grmt15:Cab15 30w DBL	EA30			4999	EA30			5789	A	+1098	MR	+333
Cab15:Grmt15 30w DBL	EB30			4999	EB30			5789	A	+1098	MR	+333
Grmt18:Cab18 36w DBL	EA36			5247	EA36			6036	A	+1098	MR	+355
Cab18:Grmt18 36w DBL	EB36			5247	EB36			6036	A	+1098	MR	+355

(listing continued on following page)

! Notes:

- All units have unfinished backs.
- LH and RH designations indicate hinge side on the single door units.
- 84.5h units have unfinished tops.
- For units with toe kick use prefix with toe kick.
- Toe kick finish is standard MRBAS, Brushed Aluminum w/Steel Tint; for polished specify MPA, Polished Aluminum.
- Pull finish is standard MRBAS, Brushed Aluminum w/Steel tint; for polished specify MPA, Polished Aluminum.
- Acrylic faces are Stylelite Arctic White standard.

+ Options:

- To specify Acrylic faces add A to spec code and add \$ total amount.
- To specify mirror add MR to spec code and add \$ amount to total.
- For Door/Cabinet locks, specify LD; add \$221.
- For Drawer locks, specify LG add \$263.

Towers 84.5h (continued)

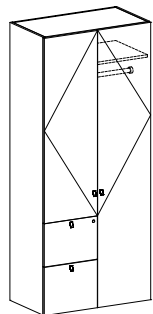
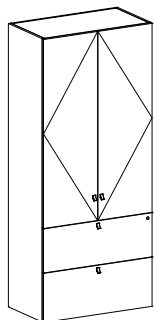
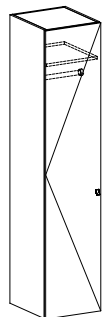

Description	Product No.		Product No.		List \$		List \$	
	20d		24d					
	Spec Code	▲	Spec Code	▲	Spec Code	Add \$	Spec Code	Add \$
	Wood1 Faces		Wood1 Faces		Acrylic Faces		Mirror	
Garment 16w LH	GL16	3528	GL16	3915	A	+1098	MR	+177
Garment 16w RH	GR16	3528	GR16	3915	A	+1098	MR	+177
• Garment 18w LH	GL18	3700	GL18	4100	A	+1098	MR	+201
Garment 18w RH	GR18	3700	GR18	4100	A	+1098	MR	+201
Garment 20w LH	GL20	3841	GL20	4249	A	+1098	MR	+223
Garment 20w RH	GR20	3841	GR20	4249	A	+1098	MR	+223
Garment 24w LH	GL24	4089	GL24	4498	A	+1098	MR	+267
Garment 24w RH	GR24	4089	GR24	4498	A	+1098	MR	+267
Cab4:2File 16w LH	HL16	4405	HL16	4934	A	+1098	MR	—
Cab4:2File 16w RH	HR16	4405	HR16	4934	A	+1098	MR	—
Cab4:2File 18w LH	HL18	4591	HL18	5101	A	+1098	MR	—
Cab4:2File 18w RH	HR18	4591	HR18	5101	A	+1098	MR	—
Cab4:2File 20w LH	HL20	4763	HL20	5321	A	+1098	MR	—
Cab4:2File 20w RH	HR20	4763	HR20	5321	A	+1098	MR	—
Cab4:2File 24w DBL	H24	5049	H24	5641	A	+1098	MR	—
• Cab4:2File 30w DBL	H30	5370	H30	5966	A	+1098	MR	—
Cab4:2File 36w DBL	H36	5656	H36	6253	A	+1098	MR	—
Cab4/2F 16:Gmt8 24w DBL	JA24	5399	JA24	6116	A	+1098	MR	—
Gmt8:Cab4/2F 16 24w DBL	JB24	5399	JB24	6116	A	+1098	MR	—
Cab4/2F 18:Gmt12 30w DBL	JA30	5650	JA30	6419	A	+1098	MR	+333
Gmt12:Cab4/2F 18 30w DBL	JB30	5650	JB30	6419	A	+1098	MR	+333
• Cab4/2F 18:Gmt18 36w DBL	JA36	5898	JA36	6665	A	+1098	MR	+355
Gmt18:Cab4/2F 18 36w DBL	JB36	5898	JB36	6665	A	+1098	MR	+355

! Notes:

- All units have unfinished backs.
- LH and RH designations indicate hinge side on the single door units.
- 84.5h units have unfinished tops.
- For units with toe kick use prefix with toe kick.
- Toe kick finish is standard MRBAS, Brushed Aluminum w/Steel Tint; for polished specify MPA, Polished Aluminum.
- Pull finish is standard MRBAS, Brushed Aluminum w/Steel tint; for polished specify MPA, Polished Aluminum.
- Acrylic faces are Stylelite Arctic White standard.

+ Options:

- To specify Acrylic faces add A to spec code and add \$ total amount.
- To specify mirror add MR to spec code and add \$ amount to total.
- For Door/Cabinet locks, specify LD; add \$221.
- For Drawer locks, specify LG add \$263.

