

PRICING & SPECIFICATION GUIDE
Andavi Collection

February 1, 2019

TUOHY

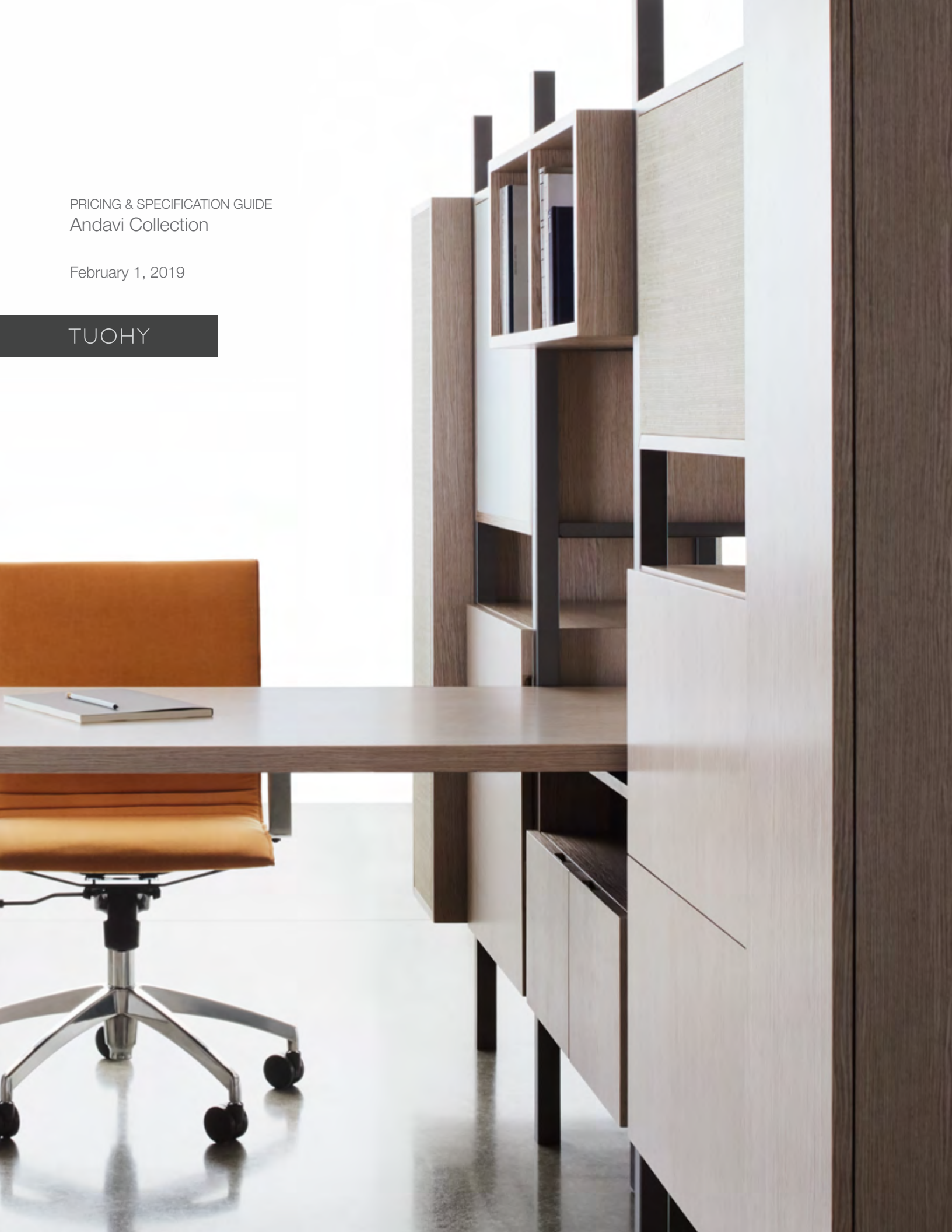

Casegoods: **Andavi**

Rules for Layout and Specification	AAN3
12w Sections	AAN4
18w Sections	AAN5
24w Sections	AAN6
30w Sections	AAN7
36w Sections	AAN8



INTERIOR
DESIGN



presented by
contract

Casegoods: **Andavi**

Design: **Annie Lee and David Rush**

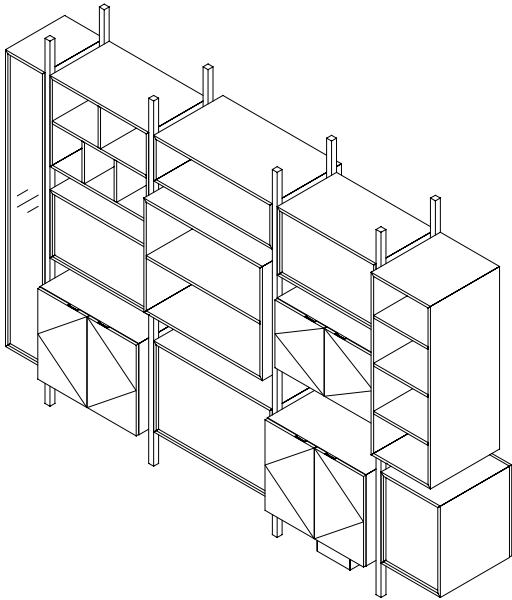

Rules for Layout and Specification:

- Specify entire unit starting with the left most section and going from top to bottom.
- Each section must contain the same width cabinets.
- Do not add the Post/Height cost for the last section, as the posts are not needed for the last section.
- Minimum gap between cabinets is 3-in
- Maximum gap between cabinets is 21-in.
- 96-in height allows 78-in of cabinet space; 69-in height allows 54-in of cabinet space.
- Storage cabinets are 9-in off the floor and 9-in below top of posts on the 96h, 9-in off the floor and 6-in below top of posts on the 69h.
- For end hanging cabinets use 12w or 18w only when facing front or back.
- Only 18w and 24w (18d only) cabinets can be used for end facing units.
- All end hanging cabinets must be taller than they are wide.
- 18d wardrobes will have a coat hook.
- 21d wardrobes will have a coat rod.
- Multiple depths can be used in the same section.
- Cabinets can be installed facing front or back.
- Overall units can be no less than 4 sections wide, and 96-in minimum width total.
- BPG is magnetic.
- All fabric is COM.
- All pricing is in Wood 1, For Wood 2 add 10%.
- Cabinets are finished all sides, mitre folded construction.
- Pulls are integrated into face; Finish is MRBAS, Metal Resin Brushed Aluminum w/ Steel Tint.
- Drawered pedestals can only be used in the lower part of a section.
- Electrical cabinets/Height Adjustable cabinets come with accessory outlets (3Duplex /1Duplex USB Charging).
- All electrical outlets are a hardwired, 2-circuit, 4-wire system.
- Do Not use two different height posts in the same run.
- Runoff can only be used with the electrical cabinet.
- Wire housings are only needed for covering the core drill not needed on every electrical cabinet.
- Specify single door cabinets/wardrobes with an [L] for left or [R] for right after Spec code for hinging.
- (M) denotes monitor-ready backs on 21d cabinets. Includes false back and wire chase; add (M) after spec code to designate cabinet.

How to Order Sections:

Specify the Post Prefix Code, code for Module, code for Center or Back material, and, if desired, code for Light. The price is the sum of the component prices for each. Example from listings on page AAN4:

Product number AND1296-ACXC-AGYF;

List Price is $607 + (1743 + 0) + (2292 + 171) = \4813 .

12w Sections

Post/Height	Prefix Code	List \$
69	AND1269	537
96	AND1296	607

Module/Height	18d	List \$	21d	List \$	Center Wood1	Back Position		Fabric (by grade—use letter code F for all)																	yds	Optional Light	
						Wood1	GlassBP	COM																			
								C	W	G	F	Gr1	Gr2	Gr3	Gr4	Gr5	Gr6	Gr7	Gr8	Gr9	Gr10	Gr11	Gr12	Gr13			Gr14
Open Shelving																											
12	AAX	1537	AAY	1583	+0	+0	+89	+43	+110	+118	+127	+137	+148	+161	+175	+191	+209	+229	+251	+276	+304	+335	+370	+410	+454	1	+470
18	ABX	1611	ABY	1665	+0	+0	+132	+62	+129	+137	+146	+156	+167	+180	+194	+210	+228	+248	+270	+295	+323	+354	+389	+429	+473	1	+470
24	ACX	1743	ACY	1818	+0	+0	+175	+85	+152	+160	+169	+179	+190	+203	+217	+233	+251	+271	+293	+318	+346	+377	+412	+452	+496	1	+513
30	ADX	1825	ADY	1898	+0	+0	+222	+105	+172	+180	+189	+199	+210	+223	+237	+253	+271	+291	+313	+338	+366	+397	+432	+472	+516	1	+513
36	AEX	1957	AEY	2058	+0	+0	+265	+128	+262	+278	+296	+316	+338	+364	+392	+424	+460	+500	+544	+594	+650	+712	+782	+862	+950	2	+557
42	AFX	2031	AFY	2140	+0	+0	+308	+148	+282	+298	+316	+336	+358	+384	+412	+444	+480	+520	+564	+614	+670	+732	+802	+882	+970	2	+557
48	AGX	2163	AGY	2292	+0	+0	+354	+171	+305	+321	+339	+359	+381	+407	+435	+467	+503	+543	+587	+637	+693	+755	+825	+905	+993	2	+600
• 54	AHX	2410	AHY	2546	+0	+0	+397	+190	+324	+340	+358	+378	+400	+426	+454	+486	+522	+562	+606	+656	+712	+774	+844	+924	+1012	2	+600
60	AJX	2542	AJY	2697	+0	+0	+440	+214	+348	+364	+382	+402	+424	+450	+478	+510	+546	+586	+630	+680	+736	+798	+868	+948	+1036	2	+642
78	AMX	2764	AMY	2951	+0	+0	+571	+276	+477	+501	+528	+558	+591	+630	+672	+720	+774	+834	+900	+975	+1059	+1152	+1257	+1377	+1509	3	+642
Cabinet Shelving																											
18	EBX	1781	EBY	1835	+0	+0	+132	+62	+129	+137	+146	+156	+167	+180	+194	+210	+228	+248	+270	+295	+323	+354	+389	+429	+473	1	—
24	ECX	1932	ECY	2007	+0	+0	+175	+85	+152	+160	+169	+179	+190	+203	+217	+233	+251	+271	+293	+318	+346	+377	+412	+452	+496	1	—
30	EDX	2042	EDY	2107	+0	+0	+222	+105	+172	+180	+189	+199	+210	+223	+237	+253	+271	+291	+313	+338	+366	+397	+432	+472	+516	1	—
36	EEX	2193	EEY	2294	+0	+0	+265	+128	+195	+203	+212	+222	+233	+246	+260	+276	+294	+314	+336	+361	+389	+420	+455	+495	+539	1	—
42	EFX	2287	EFY	2396	+0	+0	+308	+148	+282	+298	+316	+336	+358	+384	+412	+444	+480	+520	+564	+614	+670	+732	+802	+882	+970	2	—
48	EGX	2447	EGY	2576	+0	+0	+354	+171	+305	+321	+339	+359	+381	+407	+435	+467	+503	+543	+587	+637	+693	+755	+825	+905	+993	2	—
• 54	EHX	2533	EHY	2669	+0	+0	+397	+190	+324	+340	+358	+378	+400	+426	+454	+486	+522	+562	+606	+656	+712	+774	+844	+924	+1012	2	—
60	EJX	2684	EJY	2840	+0	+0	+440	+214	+348	+364	+382	+402	+424	+450	+478	+510	+546	+586	+630	+680	+736	+798	+868	+948	+1036	2	—
78	EMX	2973	EMY	3159	+0	+0	+571	+276	+477	+501	+528	+558	+591	+630	+672	+720	+774	+834	+900	+975	+1059	+1152	+1257	+1377	+1509	3	—
Wardrobe																											
• 54	—	—	FHY	2442	—	+0	+397	+190	+324	+340	+358	+378	+400	+426	+454	+486	+522	+562	+606	+656	+712	+774	+844	+924	+1012	2	—
60	—	—	FJY	2594	—	+0	+440	+214	+348	+364	+382	+402	+424	+450	+478	+510	+546	+586	+630	+680	+736	+798	+868	+948	+1036	2	—
78	—	—	FMY	2924	—	+0	+571	+276	+477	+501	+528	+558	+591	+630	+672	+720	+774	+834	+900	+975	+1059	+1152	+1257	+1377	+1509	3	—

+ Options:

Standard Post metal finish is MRTG Resin Thunder Gray. For Resin Satin Aluminum, specify MRSA; for Resin Black, specify MRB; for Resin White, specify MRW.
 Specify Back-Painted Glass (GlassBP) color: S.BLK Black or S.BWT White; custom colors on a project basis.
 For Locks, specify LD for door locks, add \$161.
 Wood prices are shown at Wood1; for Wood2, add 5%.
 Specify single door cabinets/wardrobes with an [L] for left or [R] for right after Spec code for hinging.

See Rules for Layout and Specification on page AAN3.

> How to Order Sections:

Specify the Post Prefix Code, code for Module, code for Center or Back material, and, if desired, code for Light.
 The price is the sum of the component prices for each. Example: Product number AND1296-ACXC-AGYF;
 List Price is 607 + (1743+0) + (2292+171) = \$4813.



18w Sections

Post/Height	Prefix Code	List \$
69	AND1869	587
96	AND1896	657

Module/Height	18d	List \$	21d	List \$	Center Wood1	Back Position			Fabric (by grade—use letter code F for all)																	yds	Optional Light
						Wood1	GlassBP	G	F																		
									C	W	COM	Gr1	Gr2	Gr3	Gr4	Gr5	Gr6	Gr7	Gr8	Gr9	Gr10	Gr11	Gr12	Gr13	Gr14		
Open Shelving																											
12	AAX	1692	AAY	1748	+0	+0	+89	+62	+129	+137	+146	+156	+167	+180	+194	+210	+228	+248	+270	+295	+323	+354	+389	+429	+473	1	+490
18	ABX	1778	ABY	1843	+0	+0	+132	+98	+165	+173	+182	+192	+203	+216	+230	+246	+264	+284	+306	+331	+359	+390	+425	+465	+509	1	+490
24	ACX	1953	ACY	2043	+0	+0	+175	+128	+195	+203	+212	+222	+233	+246	+260	+276	+294	+314	+336	+361	+389	+420	+455	+495	+539	1	+552
30	ADX	2051	ADY	2141	+0	+0	+222	+160	+227	+235	+244	+254	+265	+278	+292	+308	+326	+346	+368	+393	+421	+452	+487	+527	+571	1	+552
36	AEX	2227	AEY	2350	+0	+0	+265	+190	+324	+340	+358	+378	+400	+426	+454	+486	+522	+562	+606	+656	+712	+774	+844	+924	+1012	2	+614
42	AFX	2312	AFY	2443	+0	+0	+308	+222	+356	+372	+390	+410	+432	+458	+486	+518	+554	+594	+638	+688	+744	+806	+876	+956	+1044	2	+614
48	AGX	2489	AGY	2643	+0	+0	+354	+256	+390	+406	+424	+444	+466	+492	+520	+552	+588	+628	+672	+722	+778	+840	+910	+990	+1078	2	+677
• 54	AHX	2759	AHY	2923	+0	+0	+397	+288	+422	+438	+456	+476	+498	+524	+552	+584	+620	+660	+704	+754	+810	+872	+942	+1022	+1110	2	+677
60	AJX	2935	AJY	3123	+0	+0	+440	+319	+453	+469	+487	+507	+529	+555	+583	+615	+651	+691	+735	+785	+841	+903	+973	+1053	+1141	2	+739
78	AMX	3192	AMY	3413	+0	+0	+571	+416	+617	+641	+668	+698	+731	+770	+812	+860	+914	+974	+1040	+1115	+1199	+1292	+1397	+1517	+1649	3	+739
Open Cubbies																											
12	BAX	1733	BAY	1823	+0	+0	+89	+62	+129	+137	+146	+156	+167	+180	+194	+210	+228	+248	+270	+295	+323	+354	+389	+429	+473	1	+662
18	BBX	1839	BBY	1949	+0	+0	+132	+98	+165	+173	+182	+192	+203	+216	+230	+246	+264	+284	+306	+331	+359	+390	+425	+465	+509	1	+662
24	BCX	2035	BCY	2182	+0	+0	+175	+128	+195	+203	+212	+222	+233	+246	+260	+276	+294	+314	+336	+361	+389	+420	+455	+495	+539	1	+662
30	BDX	2154	BDY	2312	+0	+0	+222	+160	+227	+235	+244	+254	+265	+278	+292	+308	+326	+346	+368	+393	+421	+452	+487	+527	+571	1	+662
• 36	BEX	2366	BEY	2575	+0	+0	+265	+190	+324	+340	+358	+378	+400	+426	+454	+486	+522	+562	+606	+656	+712	+774	+844	+924	+1012	2	+662
42	BFX	2472	BFY	2700	+0	+0	+308	+222	+356	+372	+390	+410	+432	+458	+486	+518	+554	+594	+638	+688	+744	+806	+876	+956	+1044	2	+662
48	BGX	2668	BGY	2933	+0	+0	+354	+256	+390	+406	+424	+444	+466	+492	+520	+552	+588	+628	+672	+722	+778	+840	+910	+990	+1078	2	+662
Cabinet Shelving																											
24	EAX	2188	EAY	2277	+0	+0	+265	+128	+195	+203	+212	+222	+233	+246	+260	+276	+294	+314	+336	+361	+389	+420	+455	+495	+539	1	—
30	EBX	2318	EBY	2409	+0	+0	+331	+160	+227	+235	+244	+254	+265	+278	+292	+308	+326	+346	+368	+393	+421	+452	+487	+527	+571	1	—
36	ECX	2433	ECY	2539	+0	+0	+397	+190	+324	+340	+358	+378	+400	+426	+454	+486	+522	+562	+606	+656	+712	+774	+844	+924	+1012	2	—
42	EDX	2548	EDY	2662	+0	+0	+463	+222	+356	+372	+390	+410	+432	+458	+486	+518	+554	+594	+638	+688	+744	+806	+876	+956	+1044	2	—
48	EEX	2662	EEY	2784	+0	+0	+529	+256	+390	+406	+424	+444	+466	+492	+520	+552	+588	+628	+672	+722	+778	+840	+910	+990	+1078	2	—
54	EFX	2776	EFY	2906	+0	+0	+595	+288	+422	+438	+456	+476	+498	+524	+552	+584	+620	+660	+704	+754	+810	+872	+942	+1022	+1110	2	—
60	EJX	2891	EJY	3029	+0	+0	+662	+319	+453	+469	+487	+507	+529	+555	+583	+615	+651	+691	+735	+785	+841	+903	+973	+1053	+1141	2	—
• 78	EMX	3234	EMY	3404	+0	+0	+860	+416	+617	+641	+668	+698	+731	+770	+812	+860	+914	+974	+1040	+1115	+1199	+1292	+1397	+1517	+1649	3	—
Wardrobe																											
54	FHX	2867	FHY	2980	—	+0	+595	+288	+422	+438	+456	+476	+498	+524	+552	+584	+620	+660	+704	+754	+810	+872	+942	+1022	+1110	2	—
60	FJX	3070	FJY	3221	—	+0	+662	+319	+453	+469	+487	+507	+529	+555	+583	+615	+651	+691	+735	+785	+841	+903	+973	+1053	+1141	2	—
• 78	FMX	3422	FMY	3607	—	+0	+860	+416	+617	+641	+668	+698	+731	+770	+812	+860	+914	+974	+1040	+1115	+1199	+1292	+1397	+1517	+1649	3	—
Wardrobe/Shelving																											
• 54	—	—	SHX	3642	—	+0	+595	+288	+422	+438	+456	+476	+498	+524	+552	+584	+620	+660	+704	+754	+810	+872	+942	+1022	+1110	2	—
60	—	—	SJY	4038	—	+0	+662	+319	+453	+469	+487	+507	+529	+555	+583	+615	+651	+691	+735	+785	+841	+903	+973	+1053	+1141	2	—
78	—	—	SMY	4533	—	+0	+860	+416	+617	+641	+668	+698	+731	+770	+812	+860	+914	+974	+1040	+1115	+1199	+1292	+1397	+1517	+1649	3	—
Bi-Directional Wardrobe																											
• 54	—	—	GHY	3596	—	+0	+595	+288	+422	+438	+456	+476	+498	+524	+552	+584	+620	+660	+704	+754	+810	+872	+942	+1022	+1110	2	—
60	—	—	GJY	3985	—	+0	+662	+319	+453	+469	+487	+507	+529	+555	+583	+615	+651	+691	+735	+785	+841	+903	+973	+1053	+1141	2	—
78	—	—	GMY	4464	—	+0	+860	+416	+617	+641	+668	+698	+731	+770	+812	+860	+914	+974	+1040	+1115	+1199	+1292	+1397	+1517	+1649	3	—
Pedestals																											
24 (Box/File)	HCX	2460	HCY	2582	—	+0	+265	+128	+195	+203	+212	+222	+233	+246	+260	+276	+294	+314	+336	+361	+389	+420	+455	+495	+539	1	—
30 (Box/Box/File)	HDX	2762	HDY	2891	—	+0	+331	+160	+227	+235	+244	+254	+265	+278	+292	+308	+326	+346	+368	+393	+421	+452	+487	+527	+571	1	—
• 30 (File/File)	HRX	2625	HRY	2787	—	+0	+331	+160	+227	+235	+244	+254	+265	+278	+292	+308	+326	+346	+368	+393	+421	+452	+487	+527	+571	1	—

+ Options:

Standard Post metal finish is MRTG Resin Thunder Gray. For Resin Satin Aluminum, specify MRSA; for Resin Black, specify MRB; for Resin White, specify MRW. Specify Back-Painted Glass (GlassBP) color: S.BLK Black or S.BWT White; custom colors on a project basis. For Locks, specify LD for door locks, add \$161; specify LG for drawer locks, add \$223. Wood prices are shown at Wood1; for Wood2, add 5%. Specify single door cabinets/wardrobes with an [L] for left or [R] for right after Spec code for hinging.

See Rules for Layout and Specification on page AAN3.

30w Sections

Post/Height	Prefix Code	List \$
69	AND3069	599
96	AND3096	668

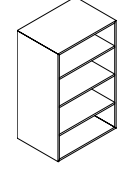
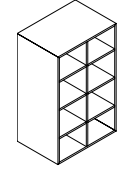
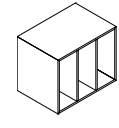
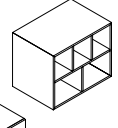
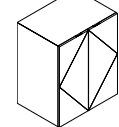
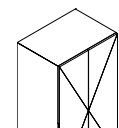
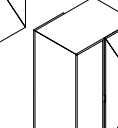
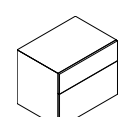
Module/Height	18d	List \$	21d	List \$	Center Wood1			Back Position			Fabric (by grade—use letter code F for all)																	yds	Optional Light
					Wood1	Wood1	GlassBP	Wood1	Wood1	GlassBP	COM	Gr1	Gr2	Gr3	Gr4	Gr5	Gr6	Gr7	Gr8	Gr9	Gr10	Gr11	Gr12	Gr13	Gr14	Gr15	Gr16		
					C	W	G	C	W	G	F																		E
Open Shelving																													
	AAX	1767	AAY	1829	+0	+0	+222	+105	+172	+180	+189	+199	+210	+223	+237	+253	+271	+291	+313	+338	+366	+397	+432	+472	+516	1	+680		
	ABX	1868	ABY	1938	+0	+0	+331	+160	+227	+235	+244	+254	+265	+278	+292	+308	+326	+346	+368	+393	+421	+452	+487	+527	+571	1	+680		
	ACX	2108	ACY	2229	+0	+0	+440	+214	+281	+289	+298	+308	+319	+332	+346	+362	+380	+400	+422	+447	+475	+506	+541	+581	+625	1	+770		
	ADX	2218	ADY	2338	+0	+0	+552	+265	+332	+340	+349	+359	+370	+383	+397	+413	+431	+451	+473	+498	+526	+557	+592	+632	+676	1	+770		
	AEX	2459	AEY	2638	+0	+0	+662	+319	+453	+469	+487	+507	+529	+555	+583	+615	+651	+691	+735	+785	+841	+903	+973	+1053	+1141	2	+859		
	AFX	2560	AFY	2747	+0	+0	+770	+374	+508	+524	+542	+562	+584	+610	+638	+670	+706	+746	+790	+840	+896	+958	+1028	+1108	+1196	2	+859		
	AGX	2801	AGY	3039	+0	+0	+883	+424	+558	+574	+592	+612	+634	+660	+688	+720	+756	+796	+840	+890	+946	+1008	+1078	+1158	+1246	2	+949		
	AHX	3079	AHY	3323	+0	+0	+991	+479	+613	+629	+647	+667	+689	+715	+743	+775	+811	+851	+895	+945	+1001	+1063	+1133	+1213	+1301	2	+949		
	AJX	3320	AJY	3615	+0	+0	+1100	+532	+666	+682	+700	+720	+742	+768	+796	+828	+864	+904	+948	+998	+1054	+1116	+1186	+1266	+1354	2	+1038		
	AMX	3619	AMY	3946	+0	+0	+1431	+692	+893	+917	+944	+974	+1007	+1046	+1088	+1136	+1190	+1250	+1316	+1391	+1475	+1568	+1673	+1793	+1925	3	+1038		
Open Cubbies																													
	BAX	1825	BAY	1898	+0	+0	+222	+105	+172	+180	+189	+199	+210	+223	+237	+253	+271	+291	+313	+338	+366	+397	+432	+472	+516	1	+680		
	BBX	1953	BBY	2039	+0	+0	+331	+160	+227	+235	+244	+254	+265	+278	+292	+308	+326	+346	+368	+393	+421	+452	+487	+527	+571	1	+680		
	BCX	2222	BCY	2361	+0	+0	+440	+214	+281	+289	+298	+308	+319	+332	+346	+362	+380	+400	+422	+447	+475	+506	+541	+581	+625	1	+680		
	BDX	2361	BDY	2502	+0	+0	+552	+265	+332	+340	+349	+359	+370	+383	+397	+413	+431	+451	+473	+498	+526	+557	+592	+632	+676	1	+680		
	BEX	2646	BEY	2852	+0	+0	+662	+319	+453	+469	+487	+507	+529	+555	+583	+615	+651	+691	+735	+785	+841	+903	+973	+1053	+1141	2	+680		
	BFX	2774	BFY	2991	+0	+0	+770	+374	+508	+524	+542	+562	+584	+610	+638	+670	+706	+746	+790	+840	+896	+958	+1028	+1108	+1196	2	+680		
	BGX	3043	BGY	3315	+0	+0	+883	+424	+558	+574	+592	+612	+634	+660	+688	+720	+756	+796	+840	+890	+946	+1008	+1078	+1158	+1246	2	+680		
Open Cubbies																													
	CAX	1884	CAY	1969	+0	+0	+222	+105	+172	+180	+189	+199	+210	+223	+237	+253	+271	+291	+313	+338	+366	+397	+432	+472	+516	1	+936		
	CBX	2039	CBY	2140	+0	+0	+331	+160	+227	+235	+244	+254	+265	+278	+292	+308	+326	+346	+368	+393	+421	+452	+487	+527	+571	1	+936		
	CCX	2190	CCY	2307	+0	+0	+440	+214	+281	+289	+298	+308	+319	+332	+346	+362	+380	+400	+422	+447	+475	+506	+541	+581	+625	1	+936		
Open Cubbies																													
	DCX	2284	DCY	2439	+0	+0	+440	+214	+281	+289	+298	+308	+319	+332	+346	+362	+380	+400	+422	+447	+475	+506	+541	+581	+625	1	+680		
	DDX	2284	DDY	2439	+0	+0	+440	+214	+281	+289	+298	+308	+319	+332	+346	+362	+380	+400	+422	+447	+475	+506	+541	+581	+625	1	+936		
Cabinet Shelving																													
	ECX	2466	ECY	2587	+0	+0	+440	+214	+281	+289	+298	+308	+319	+332	+346	+362	+380	+400	+422	+447	+475	+506	+541	+581	+625	1	—		
	EDX	2622	EDY	2743	+0	+0	+552	+265	+332	+340	+349	+359	+370	+383	+397	+413	+431	+451	+473	+498	+526	+557	+592	+632	+676	1	—		
	EEX	2923	EEY	3085	+0	+0	+662	+319	+453	+469	+487	+507	+529	+555	+583	+615	+651	+691	+735	+785	+841	+903	+973	+1053	+1141	2	—		
	EFX	3071	EFY	3257	+0	+0	+770	+374	+508	+524	+542	+562	+584	+610	+638	+670	+706	+746	+790	+840	+896	+958	+1028	+1108	+1196	2	—		
	EGX	3372	EGY	3609	+0	+0	+883	+424	+558	+574	+592	+612	+634	+660	+688	+720	+756	+796	+840	+890	+946	+1008	+1078	+1158	+1246	2	—		
Wardrobe/Shelving																													
	SHX	3815	SHY	4017	—	+0	+991	+479	+613	+629	+647	+667	+689	+715	+743	+775	+811	+851	+895	+945	+1001	+1063	+1133	+1213	+1301	2	—		
	SJX	4256	SJY	4516	—	+0	+1100	+532	+666	+682	+700	+720	+742	+768	+796	+828	+864	+904	+948	+998	+1054	+1116	+1186	+1266	+1354	2	—		
	SMX	4790	SMY	5097	—	+0	+1431	+692	+893	+917	+944	+974	+1007	+1046	+1088	+1136	+1190	+1250	+1316	+1391	+1475	+1568	+1673	+1793	+1925	3	—		
Bi-Directional Wardrobe																													
		—	GHY	3913	—	+0	+991	+479	+613	+629	+647	+667	+689	+715	+743	+775	+811	+851	+895	+945	+1001	+1063	+1133	+1213	+1301	2	—		
		—	GJY	4484	—	+0	+1100	+532	+666	+682	+700	+720	+742	+768	+796	+828	+864	+904	+948	+998	+1054	+1116	+1186	+1266	+1354	2	—		
		—	GMY	5064	—	+0	+1431	+692	+893	+917	+944	+974	+1007	+1046	+1088	+1136	+1190	+1250	+1316	+1391	+1475	+1568	+1673	+1793	+1925	3	—		
Pedestals																													
	HCX	2666	HCY	2798	—	+0	+440	+214	+281	+289	+298	+308	+319	+332	+346	+362	+380	+400	+422	+447	+475	+506	+541	+581	+625	1	—		
	HDX	3085	HDY	3146	—	+0	+552	+265	+399	+415	+433	+453	+475	+501	+529	+561	+597	+637	+681	+731	+787	+849	+919	+999	+1087	2	—		
	HRX	2951	HRY	3043	—	+0	+552	+265	+399	+415	+433	+453	+475	+501	+529	+561	+597	+637	+681	+731	+787	+849	+919	+999	+1087	2	—		

(Please continue to the next page)



30w Sections (cont.)

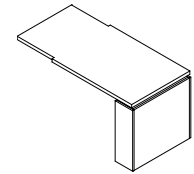
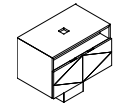
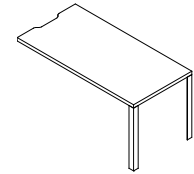
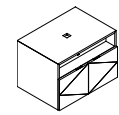

Module/Height	18d	↑	21d	↑	Center Wood1	Back Position Wood1	GlassBP	Fabric (by grade—use letter code F for all)																	yds	Optional Light	
		List \$		List \$				C	W	G	COM	Gr1	Gr2	Gr3	Gr4	Gr5	Gr6	Gr7	Gr8	Gr9	Gr10	Gr11	Gr12	Gr13			Gr14
Electrical Cabinet Double Cabinet Wire Housing	JVX WHS	2746 530	JVY WHS	2827 530	+521	+0	+331	+160	+227	+235	+244	+254	+265	+278	+292	+308	+326	+346	+368	+393	+421	+452	+487	+527	+571	1	—
Runoff																											
42w 29.5h	KFZ	1720																									
48w 29.5h	KDZ	1754																									
54w 29.5h	KHZ	1788																									
60w 29.5h	KJZ	2095																									
66w 29.5h	KKZ	2129																									
72w 29.5h	KLZ	2164																									
78w 29.5h	KMZ	2199																									
Height Adjustable Cabinet Double Cabinet	LVX	3192	—	—	—	+0	+331	+160	+227	+235	+244	+254	+265	+278	+292	+308	+326	+346	+368	+393	+421	+452	+487	+527	+571	1	—
Runoff, Adjustable Height																											
60w (18+42) 29.5h	MFZ	4237																									
66w (18+48) 29.5h	MGZ	4271																									
72w (18+54) 29.5h	MHZ	4306																									
78w (18+60) 29.5h	MJZ	4341																									
84w (18+66) 29.5h	MKZ	4375																									
90w (18+72) 29.5h	MLZ	4410																									

+ Options:
Standard Post metal finish is MRTG Resin Thunder Gray. For Resin Satin Aluminum, specify MRSA; for Resin Black, specify MRB; for Resin White, specify MRW.
Specify Back-Painted Glass (GlassBP) color: S.BLK Black or S.BWT White; custom colors on a project basis.
For Locks, specify LD; add \$161.
Wood prices are shown at Wood1; for Wood2, add 5%.

See Rules for Layout and Specification on page AAN3.

36w Sections

Post/Height	Prefix Code	List \$
69	AND3669	608
96	AND3696	678

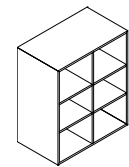
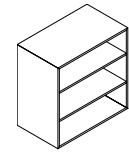

Module/Height	18d	↑	21d	↑	Center Wood1	Back Position Wood1	GlassBP	Fabric (grades)																	yds	Optional Light	
		List \$		List \$				C	W	G	COM	Gr1	Gr2	Gr3	Gr4	Gr5	Gr6	Gr7	Gr8	Gr9	Gr10	Gr11	Gr12	Gr13			Gr14
Open Shelving																											
12-1x1	AAX	1841	AAY	1918	+0	+0	+265	+128	+195	+203	+212	+222	+233	+246	+260	+276	+294	+314	+336	+361	+389	+420	+455	+495	+539	1	+680
18-1x1	ABX	1950	ABY	2035	+0	+0	+397	+190	+257	+265	+274	+284	+295	+308	+322	+338	+356	+376	+398	+423	+451	+482	+517	+557	+601	1	+680
24-2x1	ACX	2226	ACY	2370	+0	+0	+529	+256	+323	+331	+340	+350	+361	+374	+388	+404	+422	+442	+464	+489	+517	+548	+583	+623	+667	1	+770
30-2x1	ADX	2343	ADY	2486	+0	+0	+662	+319	+386	+394	+403	+413	+424	+437	+451	+467	+485	+505	+527	+552	+580	+611	+646	+686	+730	1	+770
36-3x1	AEX	2622	AEY	2832	+0	+0	+794	+381	+515	+531	+549	+569	+591	+617	+645	+677	+713	+753	+797	+847	+903	+965	+1035	+1115	+1203	2	+859
• 42-3x1	AFX	2731	AFY	2948	+0	+0	+925	+447	+581	+597	+615	+635	+657	+683	+711	+743	+779	+819	+863	+913	+969	+1031	+1101	+1181	+1269	2	+859
48-4x1	AGX	3011	AGY	3288	+0	+0	+1057	+509	+643	+659	+677	+697	+719	+745	+773	+805	+841	+881	+925	+975	+1031	+1093	+1163	+1243	+1331	2	+949
Open Cubbies																											
12-1x2	BAX	1898	BAY	1977	+0	+0	+265	+128	+195	+203	+212	+222	+233	+246	+260	+276	+294	+314	+336	+361	+389	+420	+455	+495	+539	1	+680
18-1x2	BBX	2035	BBY	2121	+0	+0	+397	+190	+257	+265	+274	+284	+295	+308	+322	+338	+356	+376	+398	+423	+451	+482	+517	+557	+601	1	+680
24-2x2	BCX	2338	BCY	2482	+0	+0	+529	+256	+323	+331	+340	+350	+361	+374	+388	+404	+422	+442	+464	+489	+517	+548	+583	+623	+667	1	+680
30-2x2	BDX	2486	BDY	2630	+0	+0	+662	+319	+453	+469	+487	+507	+529	+555	+583	+615	+651	+691	+735	+785	+841	+903	+973	+1053	+1141	2	+680
36-3x2	BEX	2809	BEY	3003	+0	+0	+794	+381	+515	+531	+549	+569	+591	+617	+645	+677	+713	+753	+797	+847	+903	+965	+1035	+1115	+1203	2	+680
• 42-3x2	BFX	2945	BFY	3147	+0	+0	+925	+447	+581	+597	+615	+635	+657	+683	+711	+743	+779	+819	+863	+913	+969	+1031	+1101	+1181	+1269	2	+680
48-4x2	BGX	3253	BGY	3513	+0	+0	+1057	+509	+643	+659	+677	+697	+719	+745	+773	+805	+841	+881	+925	+975	+1031	+1093	+1163	+1243	+1331	2	+680

(Please continue to the next page)

36w Sections (cont.)

Module/Height	18d	List \$	21d	List \$	Center Wood1	Back Position		Fabric (by grade—use letter code F for all)																	yds	Optional Light	
						Wood1	GlassBP	COM	Gr1	Gr2	Gr3	Gr4	Gr5	Gr6	Gr7	Gr8	Gr9	Gr10	Gr11	Gr12	Gr13	Gr14	Gr15	Gr16			Gr17
Open Cubbies																											
12	CAX	1957	CAY	2058	+0	+0	+265	+128	+195	+203	+212	+222	+233	+246	+260	+276	+294	+314	+336	+361	+389	+420	+455	+495	+539	1	+936
• 18 (M)	CBX	2121	CBY	2238	+0	+0	+397	+190	+257	+265	+274	+284	+295	+308	+322	+338	+356	+376	+398	+423	+451	+482	+517	+557	+601	1	+936
24	CCX	2280	CCY	2412	+0	+0	+529	+256	+323	+331	+340	+350	+361	+374	+388	+404	+422	+442	+464	+489	+517	+548	+583	+623	+667	1	+936
Open Cubbies																											
• 24—2/3	DCX	2400	DCY	2580	+0	+0	+529	+256	+323	+331	+340	+350	+361	+374	+388	+404	+422	+442	+464	+489	+517	+548	+583	+623	+667	1	+680
24—3/2	DDX	2400	DDY	2580	+0	+0	+529	+256	+323	+331	+340	+350	+361	+374	+388	+404	+422	+442	+464	+489	+517	+548	+583	+623	+667	1	+936
Cabinet Shelving																											
24 (M)	ECX	2619	ECY	2738	+0	+0	+529	+256	+323	+331	+340	+350	+361	+374	+388	+404	+422	+442	+464	+489	+517	+548	+583	+623	+667	1	—
• 30 (M)	EDX	2790	EDY	2910	+0	+0	+662	+319	+453	+469	+487	+507	+529	+555	+583	+615	+651	+691	+735	+785	+841	+903	+973	+1053	+1141	2	—
36 (M)	EEX	3141	EEY	3304	+0	+0	+794	+381	+515	+531	+549	+569	+591	+617	+645	+677	+713	+753	+797	+847	+903	+965	+1035	+1115	+1203	2	—
42	EFX	3304	EFY	3476	+0	+0	+925	+447	+581	+597	+615	+635	+657	+683	+711	+743	+779	+819	+863	+913	+969	+1031	+1101	+1181	+1269	2	—
48	EGX	3656	EGY	3862	+0	+0	+1057	+509	+643	+659	+677	+697	+719	+745	+773	+805	+841	+881	+925	+975	+1031	+1093	+1163	+1243	+1331	2	—
Bi-Directional Wardrobe																											
• 54	—	—	GHY	4139	—	+0	+1190	+575	+709	+725	+743	+763	+785	+811	+839	+871	+907	+947	+991	+1041	+1097	+1159	+1229	+1309	+1397	2	—
60	—	—	GJY	4779	—	+0	+1322	+637	+771	+787	+805	+825	+847	+873	+901	+933	+969	+1009	+1053	+1103	+1159	+1221	+1291	+1371	+1459	2	—
78	—	—	GMY	5309	—	+0	+1719	+828	+1029	+1053	+1080	+1110	+1143	+1182	+1224	+1272	+1326	+1386	+1452	+1527	+1611	+1704	+1809	+1929	+2061	3	—
Pedestals																											
24 (Box/File)	HCX	2816	HCY	2963	—	+0	+529	+256	+323	+331	+340	+350	+361	+374	+388	+404	+422	+442	+464	+489	+517	+548	+583	+623	+667	1	—
30 (Box/Box/File)	HDX	3185	HDY	3339	—	+0	+662	+319	+453	+469	+487	+507	+529	+555	+583	+615	+651	+691	+735	+785	+841	+903	+973	+1053	+1141	2	—
30 (File/File)	HRX	3039	HRY	3226	—	+0	+662	+319	+453	+469	+487	+507	+529	+555	+583	+615	+651	+691	+735	+785	+841	+903	+973	+1053	+1141	2	—
Electrical Cabinet																											
Double Cabinet	JVX	2797	JVY	2891	+550	+0	+331	+160	+227	+235	+244	+254	+265	+278	+292	+308	+326	+346	+368	+393	+421	+452	+487	+527	+571	1	—
Floor Access Cover	WHS	530	WHS	530																							
Runoff																											
42w 29.5h	KFZ	1768																									
48w 29.5h	KDZ	1809																									
54w 29.5h	KHZ	1850																									
60w 29.5h	KJZ	2164																									
66w 29.5h	KKZ	2206																									
72w 29.5h	KLZ	2247																									
78w 29.5h	KMZ	2288																									
Height Adjustable Cabinet																											
Double Cabinet	LVX	3243	—	—	—	+0	+331	+160	+227	+235	+244	+254	+265	+278	+292	+308	+326	+346	+368	+393	+421	+452	+487	+527	+571	1	—
Runoff, Adjustable Height																											
60w (18+42) 29.5h	MFZ	4395																									
66w (18+48) 29.5h	MGZ	4437																									
72w (18+54) 29.5h	MHZ	4478																									
78w (18+60) 29.5h	MJZ	4520																									
84w (18+66) 29.5h	MKZ	4561																									
90w (18+72) 29.5h	MLZ	4603																									

+ Options:
 Standard Post metal finish is MRTG Resin Thunder Gray. For Resin Satin Aluminum, specify MRSA;
 for Resin Black, specify MRB; for Resin White, specify MRW.
 Specify Back-Painted Glass (GlassBP) color: S.BLK Black or S.BWT White; custom colors on a project basis.
 For Locks, specify LD; add \$161.
 Wood prices are shown at Wood1; for Wood2, add 5%.

See Rules for Layout and Specification on page AAN3.



Blank lined area for notes or calculations.